



MAGG M.R.

QUE BIEN SE VE



TECNOLOGÍA
LED

2019

V 1.0



MAGG

M.R.

QUE BIEN SE VE

ÍNDICE

PÁGINA

GUÍA DE LECTURA	GUÍA DE LECTURA	5
	SIMBOLOGÍA	6
	IP'S	7

INTERIOR	08 - 153
-----------------------	-----------------

DECORATIVO

• M REC	11
• M ROUND	11
• M STONE	11
• FINGER	11
• PRISMA	11

SUSPENDIDOS LED

• GLOBO LED	14
-------------------	----

DOWNLIGHTS

• SERIE LUNA	19
• LUNA SSD	20
• LUNA EMPOTRADOS ESPECIALES	22
• LUNA FLAT ROUND	24
• LUNA FLAT SQ	27
• LUNA FLAT SOBREPONER	30
• LUNA FLAT SQ SOBREPONER	32
• LUNA FLAT SUSPENDIDO	35
• SERIE M	37
• SERIE POINTS	45
• SERIE FLASH	55
• SOYUZ LED	59
• SERIE ALPHA LED	61
• SERIE ISIS	65

PROYECTORES

• SERIE C	69
• SERIE SLASH	77
• SERIE ALPHA	79
• SERIE SWING 38	80

OFICINA

• SERIE CUBIC LED	84
• SERIE CUBIC SOFT	85
• SERIE CUBIC SOFT DEEP	86
• SERIE PANEL	87
• SERIE KROMOS LED	91
• SISTEMA LINEAL BL U	93
• SISTEMA LINEAL BL U MINI	96
• SERIE TREK	97

INDUSTRIAL / COMERCIAL

• LUMINARIAS SELLADAS IP 65	102
• CAMPANAS LED	113
• GABINETES METÁLICOS	117
• SERIE HIGHBAY	121

USO GENERAL

• SISTEMA LINEAL BL FLAT	127
• SISTEMA LINEAL BL STICK	143
• SERIE SWAN	147
• SERIE CL	151

INTERIOR / EXTERIOR 155 - 174

• SERIE CEILING	155
• SERIE SW	161
• SERIE CUBO	167
• SERIE W II	169

LÁMPARAS 171

• AR 111 LED	172
• LÁMPARAS LED T5	173
• LÁMPARAS LED T8	173

EXTERIOR175 - 211**EMPOTRADOS A PISO**

• SERIE EP	179
• SIDE EMITTER	189

BOLLARDS

• SERIE VENECIA	193
-----------------------	-----

PROYECTORES

• SERIE KR	197
• SERIE KR FLAT	201

SEGURIDAD

• SERIE WALLPACK	203
• CITI 23	206

ALUMBRADO PÚBLICO

• SERIE CITI	207
--------------------	-----

FLUORESCENTE 214-230

DECO	216
SUSPENDIDOS	219
FAROLAS	220
EMPOTRADOS DIRIGIBLES	221
EMPOTRADOS FIJOS	222
LINEALES / SOBREPONER	223
OFFICE	224
SUBURBANO	224
LINEALES IP	225
BALASTROS	226
TRANSFORMADORES	229
ACCESORIOS	230
ÍNDICE DE CLAVES	231

GUÍA DE LECTURA

NOMBRE DE LA FAMILIA

CATEGORÍA



Categoría: **DOWNLIGHTS**
 Familia: **POINTS MICRO**

NOMBRE DE LA LUMINARIA

INFO. FOTOMÉTRICA

INFO. ELÉCTRICA

POINTS MICRO I

CLAVE	W	V~	FP	Hz		TEMP. DE COLOR	lm	lm/W	ÁNGULO	IRC	COLOR	PESO
L5914-YE4	4,5	100-240	>0.9	50/60		3000K	225	50	20°	≥82		128 gr
L5914-YI4						4000K	245	54				
L5914-YEJ						3000K	235	52	40°			
L5914-YIJ						4000K	250	55				

CLAVES

PESO

*Este producto es atenuable en el rango de 100-240V~ Por fase (Dimmer).

 59x59 mm



IMAGEN DEL PRODUCTO

CURVA FOTOMÉTRICA

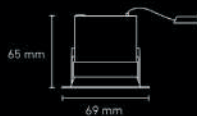

DIMENSIONES DEL PRODUCTO

SIMBOLOGÍA

W POTENCIA

V~ TENSIÓN DE ALIMENTACIÓN

FP FACTOR DE POTENCIA

Hz FRECUENCIA

 ATENUABLE

 LÁMPARA PARA LED

 LÁMPARA AR111

 LÁMPARA LINEAL LED

K TEMPERATURA DE COLOR

lm FLUJO LUMINOSO

IRC ÍNDICE DE REPRODUCCIÓN CROMÁTICA

 APERTURA

 VIDA ÚTIL

 EMPOTRADO A MURO

 EMPOTRADO A PISO

 EMPOTRADO A TECHO

 SOBREPONER A MURO

 SOBREPONER A PISO

 SOBREPONER A TECHO

 SUSPENDIDO

 INTEGRAR A RIEL

 BOTE OCTAGONAL

IP GRADO DE PROTECCIÓN

gr PESO

 ROTACIÓN HORIZONTAL

 INCLINACIÓN

 APERTURA CUADRADA DE PLAFÓN (mm)

 APERTURA CIRCULAR DE PLAFÓN (mm)

 ESTACA

IP (ÍNDICE DE PROTECCIÓN)

PRIMER DÍGITO

IP	PROTECCIÓN CONTRA OBJETOS	EFFECTIVIDAD
0	NINGUNA	NINGUNA PROTECCIÓN CONTRA INTROMISIÓN DE OBJETOS.
1	>50mm	PROTEGIDO CONTRA LA INTRODUCCIÓN DE DE OBJETOS SÓLIDOS MAYORES A 50 mm.
2	>12mm	PROTEGIDO CONTRA INTRODUCCIÓN DE OBJETOS DE DIMENSIONES MAYORES A 12 mm. COMO DEDOS U OBJETOS SIMILARES.
3	>25mm	CONTRA INTRODUCCIÓN DE OBJETOS DE DIMENSIONES MAYORES A 25 MILÍMETROS COMO HERRAMIENTAS, CABLES GRUESOS, ETC.
4	>1mm	PROTEGIDO CONTRA LA INTRODUCCIÓN DE DE OBJETOS SÓLIDOS MAYORES A UN MILÍMETRO. MAYORÍA DE LOS CABLES, TORNILLERÍA, ETC.
5	POLVO	PROTEGIDO CONTRA LA PENETRACIÓN DE POLVO.
6	POLVO FINO	NINGUNA PENETRACIÓN DE POLVO.

SEGUNDO DÍGITO

IP	PROTECCIÓN CONTRA AGUA	DETALLES
0	NINGUNA	NO ESTA PROTEGIDO.
1	GOTEO DE AGUA	PROTEGIDO CONTRA EL GOTEO VERTICAL DE AGUA Y EL POLVO.
2	AGUA GOTEAANDO INCLINACIÓN A 15°	PROTEGIDO CONTRA EL GOTEO VERTICAL DE AGUA CON UNA INCLINACIÓN DE 15°
3	LLUVIA	PROTEGIDO CONTRA LA LLUVIA
4	PROYECCIÓN DE AGUA	PROTEGIDO CONTRA PROYECCIÓN DE AGUA DESDE CUALQUIER DIRECCIÓN.
5	POTENTE CHORRO DE AGUA	PROTEGIDO CONTRA CHORRO DE AGUA A PRESIÓN DESDE CUALQUIER DIRECCIÓN.
6	PROTECCIÓN TORRENTE DE AGUA	PROTECCIÓN CONTRA TORRENTE DE AGUA HACIA EL EQUIPO DESDE CUALQUIER DIRECCIÓN.
7	INMERSIÓN A 1m TEMPORAL	PROTEGIDO CONTRA INMERSIÓN EN AGUA EN CONDICIONES DEFINIDAS DE PRESIÓN Y TIEMPO (A 1M DE INMERSIÓN)
8	INMERSIÓN PROLONGADA	PROTEGIDO CONTRA INMERSIÓN EN AGUA EN CONDICIONES DEFINIDAS POR LAS ESPECIFICACIONES O EL FABRICANTE (A MAS DE 1M DE SUMERSIÓN)

INTERIORES

Los usuarios de los espacios interiores buscan de manera inconsciente, una correspondencia entre el espacio y su ambiente así como contar con una sensación de pertenencia. Esto se logra con la iluminación correcta y bien aplicada, por lo que resulta primordial contar con las herramientas necesarias para éste objetivo.

En general ésto nos obliga a desarrollar un amplio espectro de productos con variedad de prestaciones como tamaños, potencias, flujos luminosos, temperaturas de color y características eléctricas, que brindan una solución total a sus proyectos en aplicaciones como residencial, comercial, corporativo, etc.

Lo invitamos a acercarse a nuestra área de ventas para asesorarlo y poder dar solución a sus proyectos en iluminación.





355°



90°



PRISMA

DECO LED

Ésta familia se destaca por su propuesta de diseño vanguardista y minimalista.

Serie de luminarias para sobreponer en muros o plafón. De proyección de luz suave y homogénea para interiores. Diseñada con 4 siluetas iluminadas y un cilindro tipo proyector montados en bases de acero con una combinación de acabados gris acero y acero inoxidable en formatos de 1 a 3 unidades dirigibles nos dan un toque de actualidad a los espacios.



M REC



M ROUND



M STONE







FINGER







PRISMA

Categoría: DECORATIVO

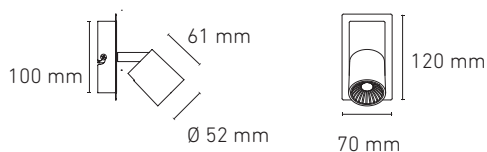
Familia: DECO LED

CLAVE	NOMBRE	W	V-	Hz		TEMP. DE COLOR	lm	lm/W	ÁNGULO	IRC	COLOR	PESO
L6101-8E0	M REC I	4.5	100- 240	50/60	Por Fase	3000K	200	44	-	>90		240 gr
L6101-830						6000K						
L6102-8E0	M ROUND I					3000K						
L6102-830						6000K						
L6103-8E0	M STONE I					3000K						
L6103-830						6000K						
L6104-8E0	FINGER I	3.5	100- 240	50/60	Por Fase	3000K	150	43	-	>90		220 gr
L6104-830						6000K						
L6105-8E4	PRISMA I	4.5	100- 240	50/60	Por Fase	3000K	250	55	20°	>90		298 gr
L6105-834						6000K						



CLAVE	NOMBRE	W	V-	Hz		TEMP. DE COLOR	lm	lm/W	ÁNGULO	IRC	COLOR	PESO
L6106-8E0	M REC II	9	100- 240	50/60	Por Fase	3000K	2x200	44	-	>90		360 gr
L6106-830						6000K						
L6107-8E0	M ROUND II					3000K						
L6107-830						6000K						
L6108-8E0	M STONE II					3000K						
L6108-830						6000K						
L6109-8E0	FINGER II	7	100- 240	50/60	Por Fase	3000K	2x150	43	-	>90		330 gr
L6109-830						6000K						
L6110-8E4	PRISMA II	8.5	100- 240	50/60	Por Fase	3000K	2x230	53	20°	>90		360 gr
L6110-834						6000K						

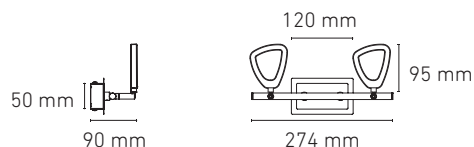
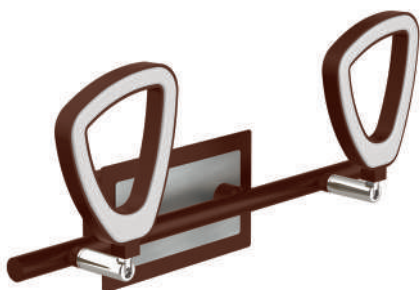

CLAVE	NOMBRE	W	V-	Hz		TEMP. DE COLOR	lm	lm/W	ÁNGULO	IRC	COLOR	PESO
L6111-8E0	M REC III	13.5	100- 240	50/60	Por Fase	3000K	3x200	44	-	>90		600 gr
L6111-830						6000K						
L6112-8E0	M ROUND III					3000K						
L6112-830						6000K						
L6113-8E0	M STONE III					3000K						
L6113-830						6000K						
L6114-8E0	FINGER III	10.5	3000K	3x150	43	560 gr						
L6114-830							6000K					
L6115-8E4	PRISMA III	13	3000K	3x230	53	20°	600 gr					
L6115-834			6000K									

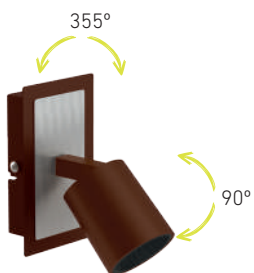
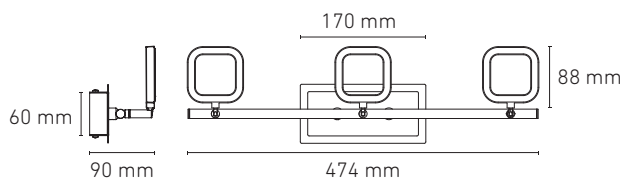
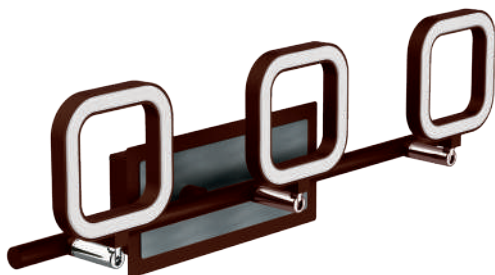

* Color gris metálico, sobre pedido.

SUSPENDIDOS LED



GLOBE LED

CLAVE	MODELO	W	V~	Hz	TEMP. DE COLOR	IRC	COLOR
L6701-1E0	GLOBE 6"	7	100- 240	50/60	3000K	>82	□
L6701-130	GLOBE 6"				6000K		
L6702-1E0	GLOBE 8"	11.5			3000K		
L6702-130	GLOBE 8"				6000K		
L6703-1E0	GLOBE 10"	17			3000K		
L6703-130	GLOBE 10"				6000K		
L6704-1E0	GLOBE 12"	23			3000K		
L6704-130	GLOBE 12"				6000K		
L6705-1E0	GLOBE 14"	31			3000K		
L6705-130	GLOBE 14"				6000K		

Opcional color níquel satin
 Altura 2000 mm Máx.

6"



8"



10"



12"



14"



DOWNLIGHTS

SERIE LUNA EMPOTRAR

LUNA SSD



LUNA 3 SSD LUNA 6 SSD LUNA 9 SSD LUNA 9 SSD IP65 LUNA 9 PLUS SSD LUNA 16 SSD LUNA 23 SSD

20-21

LUNA ESPECIALES



LUNA 9 BÁSICO LUNA 9E LUNA 6 TF LUNA 9 TF LUNA 13 TF

22-23

LUNA FLAT RD



LUNA 3 FLAT LUNA 6 FLAT LUNA 9 FLAT LUNA 13 FLAT LUNA 18 FLAT LUNA 25 FLAT

24-26

SERIE LUNA FLAT SQ EMPOTRAR



SQ 3 SQ 6 SQ 9 SQ 13 SQ 18 SQ 25

27-29

SERIE LUNA SOBREPONER



LUNA 9 S LUNA 13 S LUNA 18 S LUNA 25 S LUNA 35 S LUNA 45 S

30-31

SERIE LUNA FLAT SQ SOBREPONER



SQ 9 S SQ 13 S SQ 18 S SQ 25 S SQ 30 S SQ 37 S SQ 45 S

32-34

SERIE LUNA SUSPENDER



LUNA 35 LUNA 45

35

SERIE M EMPOTRAR



M 500 M 750 M 1400 M 2300 M 3600 M 7000

38-43

SERIE POINTS

MICRO



POINTS
MICRO I

POINTS
MICRO II

POINTS
MICRO III

..... 46-47

MINI



POINTS
MINI I

POINTS
MINI II

POINTS
MINI III

..... 48-49

MP



POINTS
MP I

POINTS
MP II

POINTS
MP III

..... 50-51

AP



POINTS
AP I

POINTS
AP II

POINTS
AP III

..... 52-53

SERIE FLASH

FLASH D



FLASH
D I

FLASH
D II

FLASH
D III

..... 56-57

PLANO



FLASH I
PLANO

FLASH II
PLANO

FLASH III
PLANO

..... 58

SERIE SOYUZ LED



SOYUZ LED

..... 59

SERIE ALPHA

EMPOTRAR



ALPHA
ROUND
LED

ALPHA I
LED

ALPHA II LED

ALPHA III LED

ALPHA IV LED

..... 62-63

SUSPENDER



ALPHA II
SUSPENDER

ALPHA III
SUSPENDER

ALPHA IV L
SUSPENDER

ALPHA IV
SUSPENDER

..... 64

SERIE ISIS



ISIS I

ISIS II

ISIS III

ISIS PIN
HOLE I

ISIS PIN HOLE II

..... 65



Por fase.



> 50,000 hrs.



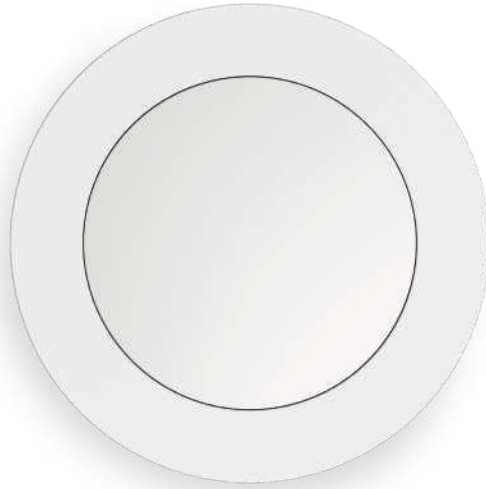

SERIE LUNA

Downlight de diseño y apariencia sencilla para iluminación general que se destaca por su iluminación difusa y homogénea caracterizada por sus pantallas opalinas que ocultan la fuente luminosa y permiten el paso de luz brindando eficiencias de hasta 92 lm/W.

Su gran variedad de tamaños, potencias, formatos como circulares, cuadrados, para empotrar, sobreponer y suspender, hacen de la Serie Luna sea una familia de luminarias muy completa para cubrir necesidades de iluminación general a diferentes escalas y prácticamente para cualquier proyecto.

Categoría: DOWNLIGHTS
 Familia: SERIE LUNA SSD

LUNA 3 SSD

CLAVE	W	V~	FP	Hz		TEMP. DE COLOR	lm	lm/W	IRC	COLOR	PESO	IP
L6345-1E0	4.5	105-140	>0.95	50/60	Por Fase	3000K	182	52	>90	□	160 gr	IP 50
4000K						200	57					
6000K												

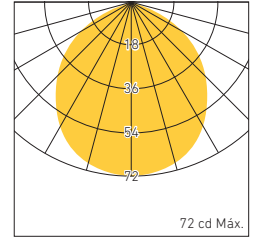

SSD SOLID STATE DRIVER

78 mm

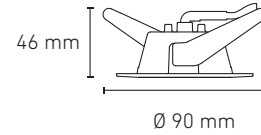

LUNA 6 SSD

CLAVE	W	V~	FP	Hz		TEMP. DE COLOR	lm	lm/W	IRC	COLOR	PESO	IP
L5074-1E0	7	105-140	>0.95	50/60	Por Fase	3000K	370	61	>90	□	180 gr	IP 50
L5074-1I0						4000K	380	63		■		
L5074-BI0						6000K				□		
L5074-130												

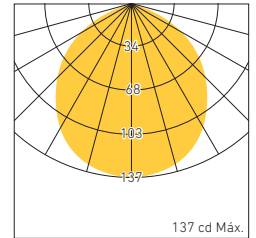

SSD SOLID STATE DRIVER

88 mm

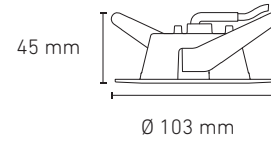

LUNA 9 SSD

CLAVE	W	V~	FP	Hz		TEMP. DE COLOR	lm	lm/W	IRC	COLOR	PESO	IP	
L5071-1E0	10.3	105-140	>0.95	60	Por Fase	3000K	700	77	>90	□	270 gr	IP 50	
L5071-BE0						4000K				82			■
L5071-1I0						6000K							□
L5071-BI0								■					
L5071-130								□					
L5071-B30								■					

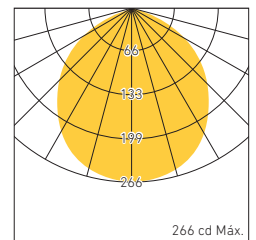

SSD SOLID STATE DRIVER

129 mm

Bote Octogonal

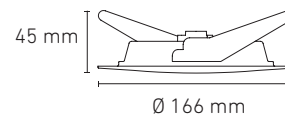

LUNA 9 SSD IP65

CLAVE	W	V-	FP	Hz		TEMP. DE COLOR	lm	lm/W	IRC	COLOR	PESO	IP
L5008-1E0	10.3	105-140	>0.95	50/60	Por Fase	3000K	700	82	>90	□	270 gr	IP 65
L5008-1I0						4000K						
L5008-130						6000K						

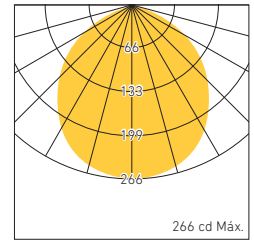

SSD SOLID STATE DRIVER

120 mm

Bote Octagonal

43 mm

 Ø 166 mm

LUNA 9 PLUS SSD

CLAVE	W	V-	FP	Hz		TEMP. DE COLOR	lm	lm/W	IRC	COLOR	PESO	IP
L6395-1E0	12	105-140	>0.95	50/60	Por Fase	3000K	888	74	>90	□	270 gr	IP 50
L6395-1I0						4000K	950	79				
L6395-130						6000K						

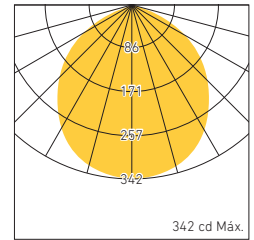

SSD SOLID STATE DRIVER

129 mm

Bote Octagonal

38 mm

 Ø 166 mm

LUNA 16 SSD

CLAVE	W	V-	FP	Hz		TEMP. DE COLOR	lm	lm/W	IRC	COLOR	PESO	IP
L5072-1E0	18.4	105-140	>0.95	50/60	Por Fase	3000K	1120	67	>90	□	660 gr	IP 50
L5072-1I0						4000K	1200	73				
L5072-130						6000K						

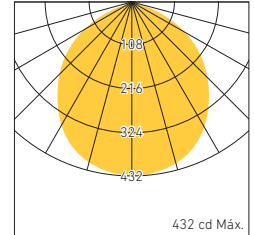

SSD SOLID STATE DRIVER

175 mm

57 mm

 Ø 203 mm

LUNA 23 SSD

CLAVE	W	V-	FP	Hz		TEMP. DE COLOR	lm	lm/W	IRC	COLOR	PESO	IP
L5073-1E0	24.2	105-140	>0.95	50/60	Por Fase	3000K	1520	76	>90	□	960 gr	IP 50
L5073-1I0						4000K	1600	80				
L5073-130						6000K						

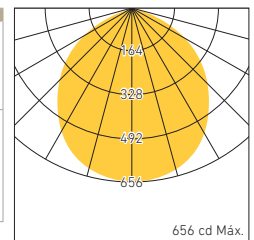

SSD SOLID STATE DRIVER

220 mm

62 mm

 Ø 253 mm

Categoría: DOWNLIGHTS
 Familia: EMPOTRADOS ESPECIALES

LUNA 9 BÁSICO

CLAVE	W	V~	FP	Hz	TEMP. DE COLOR	lm	lm/W	IRC	COLOR	PESO	IP
L6391-1E0	6	90-140	0.5	50/60	3000K	590	94	≥74	□	105 gr	IP 50
L6391-110					4000K						
L6391-130					6000K						

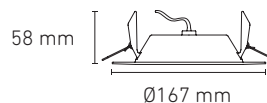
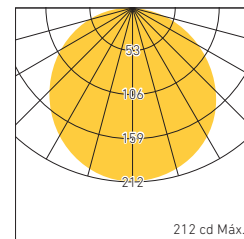

LUNA 9E

CLAVE	W	V~	FP	Hz	TEMP. DE COLOR	lm	lm/W	IRC	COLOR	PESO	IP
L6356-1E0	9	100-240	0.5	50/60	3000K	690	72	>82	□	196 gr	IP 50
L6356-BE0							■				
L6356-B10							□				
L6356-110					4000K	720	75				
L6356-130					760	84					
L6356-B30					6000K	720	75		■		

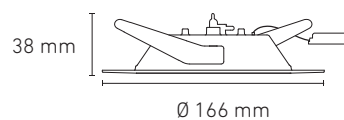
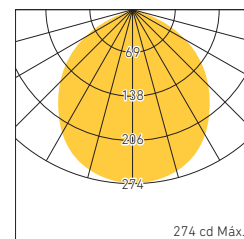

LUNA 6 TF

CLAVE	W	V~	FP	Hz	TEMP. DE COLOR	lm	lm/W	IRC	COLOR	PESO	IP
L5004-110	6	100-240	>0.5	50/60	4000K	520	86	≥82	□	59 gr	IP 50
L5004-130					6000K						

Opcional atenuable



94 mm

13 mm



Ø 103 mm

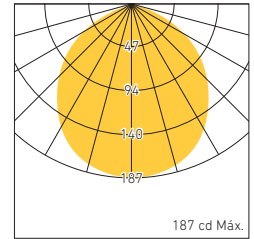

187 cd Máx.

LUNA 9 TF

CLAVE	W	V~	FP	Hz	TEMP. DE COLOR	lm	lm/W	IRC	COLOR	PESO	IP
L5005-110	9	100-240	>0.5	50/60	4000K	760	84	≥82	□	142 gr	IP 50
L5005-130					6000K						

Opcional atenuable



94 mm

13 mm



Ø 155 mm

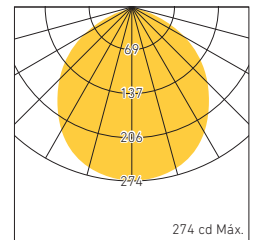

274 cd Máx.

LUNA 13 TF

CLAVE	W	V~	FP	Hz	TEMP. DE COLOR	lm	lm/W	IRC	COLOR	PESO	IP
L5006-110	13	100-240	>0.5	50/60	4000K	1200	92	≥82	□	221 gr	IP 50
L5006-130					6000K						

Opcional atenuable



174 mm

23 mm



Ø 200 mm

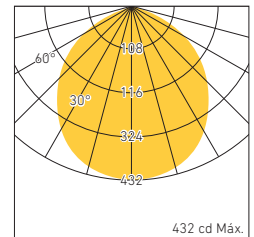

432 cd Máx.

Categoría: DOWNLIGHTS
 Familia: SERIE LUNA FLAT ROUND

LUNA 3 FLAT BASICO

CLAVE	W	V-	FP	Hz	TEMP. DE COLOR	lm	lm/W	IRC	COLOR	PESO	IP
L6601-1E0	3.5	90-140	0.5	50/60	3000K	225	64	≥82	□	110 gr	IP 50
L6601-1I0					4000K	240	69				
L6601-130					6000K						

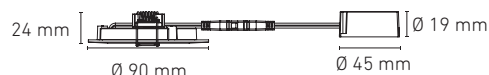
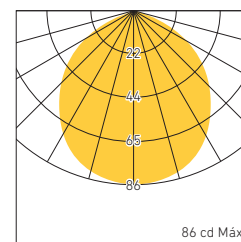

LUNA 6 FLAT BASICO

CLAVE	W	V-	FP	Hz	TEMP. DE COLOR	lm	lm/W	IRC	COLOR	PESO	IP
L6602-1E0	6	90-140	0.5	50/60	3000K	378	63	≥82	□	180 gr	IP 50
L6602-1I0					4000K	440	70				
L6602-130					6000K						

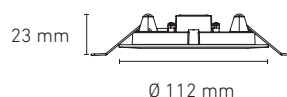
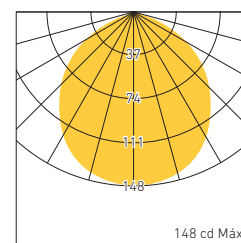

LUNA 9 FLAT BASICO

CLAVE	W	V-	FP	Hz	TEMP. DE COLOR	lm	lm/W	IRC	COLOR	PESO	IP
L6603-1E0	9	90-140	0.5	50/60	3000K	711	79	≥82	□	260 gr	IP 50
L6603-1I0					4000K	690	71				
L6603-130					6000K						

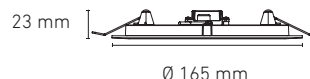
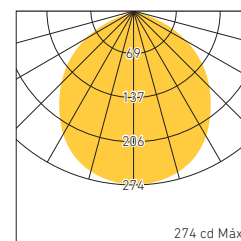

LUNA 13 FLAT BASICO

CLAVE	W	V-	FP	Hz	TEMP. DE COLOR	lm	lm/W	IRC	COLOR	PESO	IP
L6604-1E0	14	90-140	0.5	50/60	3000K	1135	87	≥82	□	346 gr	IP 50
L6604-1I0					4000K	1160	82				
L6604-130					6000K						

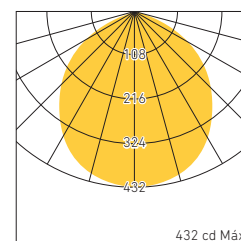

LUNA 3 FLAT ESTANDAR

CLAVE	W	V~	FP	Hz	TEMP. DE COLOR	lm	lm/W	IRC	COLOR	PESO	IP
L6347-1E0	3.5	100-240	>0.5	50/60	3000K	225	64	≥90	□	110 gr	IP 50
L6347-1I0					4000K	240	69				
L6347-130					6000K						

Opcional atenuable

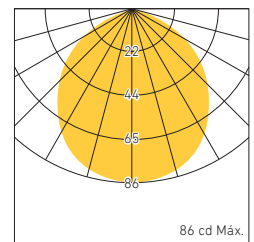

LUNA 6 FLAT ESTANDAR

CLAVE	W	V~	FP	Hz	TEMP. DE COLOR	lm	lm/W	IRC	COLOR	PESO	IP
L6352-1E0	6	100-240	>0.5	50/60	3000K	378	63	≥90	□	180 gr	IP 50
L6352-1I0					4000K	460	76				
L6352-130					6000K						

Opcional atenuable

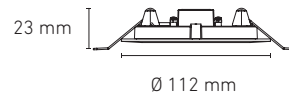
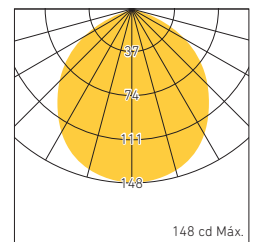

LUNA 9 FLAT ESTANDAR

CLAVE	W	V~	FP	Hz	TEMP. DE COLOR	lm	lm/W	IRC	COLOR	PESO	IP
L6359-1E0	9	100-240	>0.5	50/60	3000K	711	79	≥90	□	260 gr	IP 50
L6359-1I0					4000K	760	84				
L6359-130					6000K						

Opcional atenuable

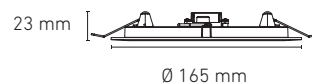
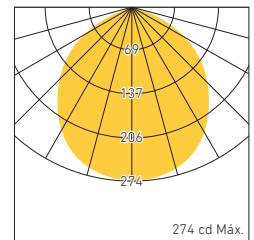

LUNA 13 FLAT ESTANDAR

CLAVE	W	V~	FP	Hz	TEMP. DE COLOR	lm	lm/W	IRC	COLOR	PESO	IP
L6335-1E0	13	100-240	>0.5	50/60	3000K	1135	87	≥90	□	346 gr	IP 50
L6335-110					4000K	1200	92				
L6335-130					6000K						

Opcional atenuable



174 mm

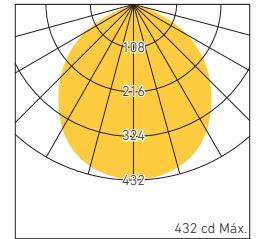
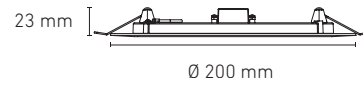

LUNA ROUND 18 FLAT ESTANDAR

CLAVE	W	V~	FP	Hz	TEMP. DE COLOR	lm	lm/W	IRC	COLOR	PESO	IP
L6340-1E0	18	100-240	>0.5	50/60	3000K	1550	86	≥90	□	506 gr	IP 50
L6340-110					4000K	1650	91				
L6340-130					6000K						

Opcional atenuable



223 mm

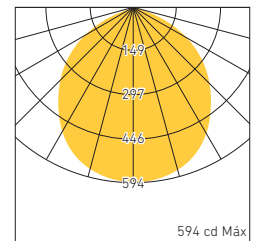
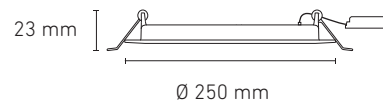

LUNA ROUND 25 FLAT ESTANDAR

CLAVE	W	V~	FP	Hz	TEMP. DE COLOR	lm	lm/W	IRC	COLOR	PESO	IP
L6341-1E0	25	100-305	>0.9	50/60	3000K	2200	88	≥90	□	915 gr	IP 50
L6341-110					4000K	2300	92				
L6341-130					6000K						

Opcional atenuable



273 mm

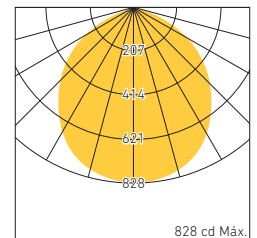
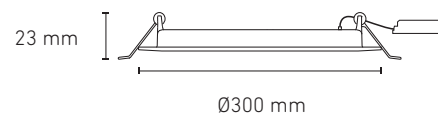

Nota 1: Driver disponible en un rango operable de 100- 305, con alternacion en un rango de 100- 240 V, y factor de potencia >0.9.
 Nota 2: Este producto puede ser atenuable, en un rango de 0 - 10, con un controlador por fase (dimmer) sobre pedido.

Categoría: DOWNLIGHTS
 Familia: SERIE LUNA FLAT SQUARE

SQ 3 FLAT BASICO

CLAVE	W	V-	FP	Hz	TEMP. DE COLOR	lm	lm/W	IRC	COLOR	PESO	IP
L6611-1E0	3.5	90-140	0.5	50/60	3000K	214	61	≥82	□	112 gr	IP 50
L6611-130					6000K	230	66				

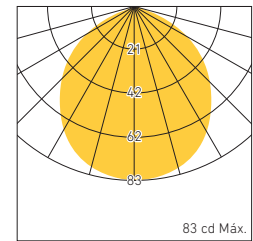

72x72 mm

24 mm



SQ 6 FLAT BASICO

CLAVE	W	V-	FP	Hz	TEMP. DE COLOR	lm	lm/W	IRC	COLOR	PESO	IP
L6612-1E0	6	90-140	0.5	50/60	3000K	378	63	≥82	□	146 gr	IP 50
L6612-130					6000K	401	68				

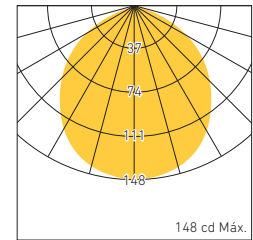

88x88 mm

24 mm

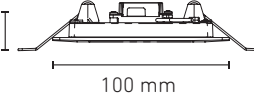

SQ 9 FLAT BASICO

CLAVE	W	V-	FP	Hz	TEMP. DE COLOR	lm	lm/W	IRC	COLOR	PESO	IP
L6613-1E0	9	90-140	0.5	50/60	3000K	648	72	≥82	□	238 gr	IP 50
L6613-110					4000K	698	78				
L6613-130					6000K	698	77				

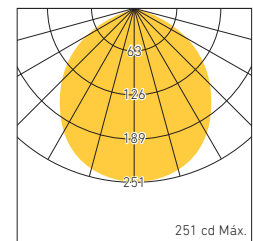

123x123 mm

24 mm

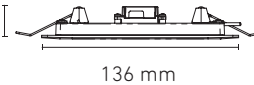

SQ 13 FLAT BASICO

CLAVE	W	V-	FP	Hz	TEMP. DE COLOR	lm	lm/W	IRC	COLOR	PESO	IP
L6614-1E0	13	90-140	0.5	50/60	3000K	1200	92	≥82	□	358 gr	IP 50
L6614-110					4000K						
L6614-130					6000K						

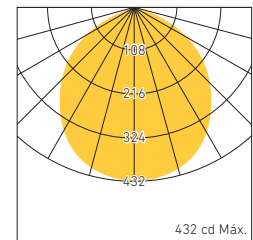

158x158 mm

24 mm



SQ 3 FLAT ESTANDAR

CLAVE	W	V~	FP	Hz	TEMP. DE COLOR	lm	lm/W	IRC	COLOR	PESO	IP
L6360-1E0	3.5	100-240	>0.5	50/60	3000K	214	61	≥90	□	112 gr	IP 50
L6360-130					6000K	230	66				

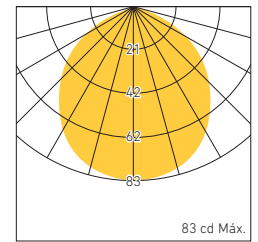

Opcional atenuable



72x72 mm

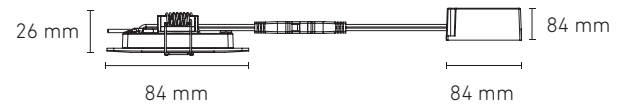

SQ 6 FLAT ESTANDAR

CLAVE	W	V~	FP	Hz	TEMP. DE COLOR	lm	lm/W	IRC	COLOR	PESO	IP
L6361-1E0	6	100-240	>0.5	50/60	3000K	378	63	≥90	□	146 gr	IP 50
L6361-130					6000K	410	68				

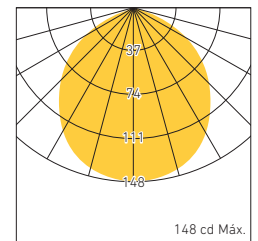

Opcional atenuable



88x88 mm

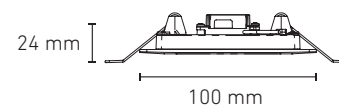

SQ 9 FLAT ESTANDAR

CLAVE	W	V~	FP	Hz	TEMP. DE COLOR	lm	lm/W	IRC	COLOR	PESO	IP
L6362-1E0	9	100-240	>0.5	50/60	3000K	648	72	≥90	□	238 gr	IP 50
L6362-1I0					4000K	698	78				
L6362-130					6000K	77					

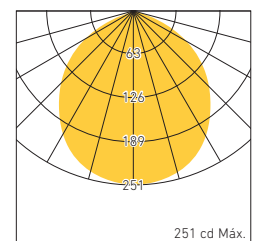

Opcional atenuable



123x123 mm

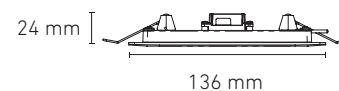

SQ 13 FLAT ESTANDAR

CLAVE	W	V~	FP	Hz	TEMP. DE COLOR	lm	lm/W	IRC	COLOR	PESO	IP
L6363-1E0	13	100-240	>0.5	50/60	3000K	1200	92	≥90	□	358 gr	IP 50
L6363-1I0					4000K						
L6363-130					6000K						

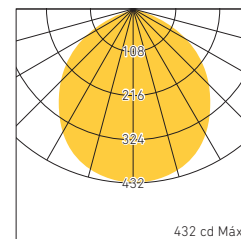

Opcional atenuable



158x158 mm

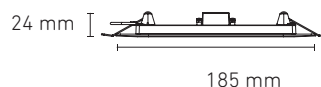

SQ 18 FLAT ESTANDAR

CLAVE	W	V~	FP	Hz	TEMP. DE COLOR	lm	lm/W	IRC	COLOR	PESO	IP
L6364-1E0	18	100-240	0.5	50/60	3000K	1512	84	≥90	□	506 gr	IP 50
L6364-1I0					4000K						
L6364-130					6000K	1650	92				

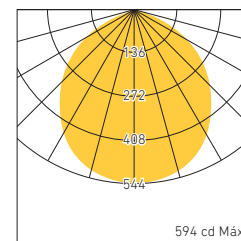

Opcional atenuable



208x208 mm

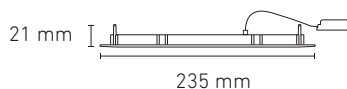

SQ 25 FLAT ESTANDAR

CLAVE	W	V~	FP	Hz	TEMP. DE COLOR	lm	lm/W	IRC	COLOR	PESO	IP
L6370-1I0	25	100-305	>0.9	50/60	4000K	2300	92	≥90	□	995 gr	IP 50

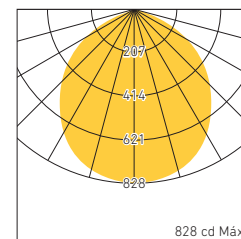

Opcional atenuable



258x258 mm

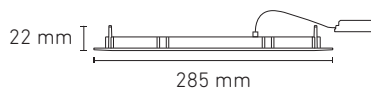

Categoría: DOWNLIGHTS
 Familia: SERIE LUNA FLAT SOBREPONER

LUNA 9 FLAT S

CLAVE	W	V-	FP	Hz	TEMP. DE COLOR	lm	lm/W	IRC	COLOR	PESO	IP
L6377-110	9	100-240	>0.5	50/60	4000K	760	84	≥90	□	260 gr	IP 50
L6377-130					6000K						

Opcional atenuable

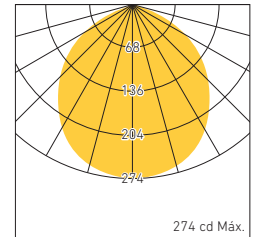
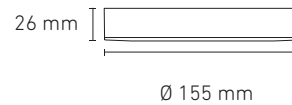

LUNA 13 FLAT S

CLAVE	W	V-	FP	Hz	TEMP. DE COLOR	lm	lm/W	IRC	COLOR	PESO	IP
L6374-1E0	13	100-240	>0.5	50/60	3000K	1135	87	≥90	□	346 gr	IP 50
L6374-110					4000K	1200	92				
L6374-130					6000K						

Opcional atenuable

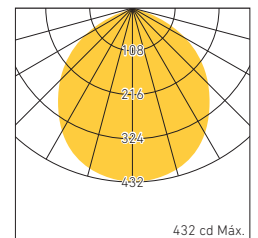
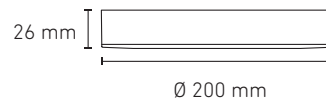

LUNA 18 FLAT S

CLAVE	W	V-	FP	Hz	TEMP. DE COLOR	lm	lm/W	IRC	COLOR	PESO	IP
L6373-1E0	18	100-240	>0.5	50/60	3000K	1550	86	≥90	□	506 gr	IP 50
L6373-110					4000K	1650	92				
L6373-130					6000K						

Opcional atenuable

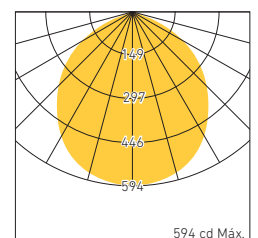
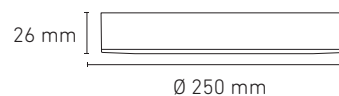

LUNA 25 FLAT S

CLAVE	W	V-	FP	Hz	TEMP. DE COLOR	lm	lm/W	IRC	COLOR	PESO	IP
L6372-1E0	25	100-305	>0.9	50/60	3000K	2200	88	≥90	□	1,125 gr	IP 50
L6372-1I0					4000K	2300	92				
L6372-130					6000K						

Opcional atenuable

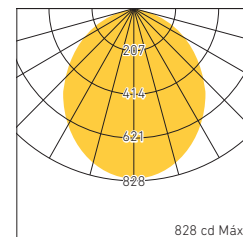
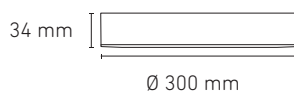

LUNA 35 FLAT S

CLAVE	W	V-	FP	Hz	TEMP. DE COLOR	lm	lm/W	IRC	COLOR	PESO	IP
L6375-1I0	35	100-305	>0.9	50/60	4000K	3200	91	≥86	□	1,905 gr	IP 50
L6375-130					6000K						

Opcional atenuable

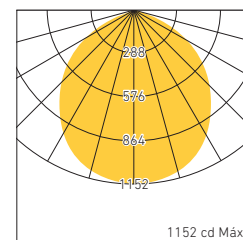
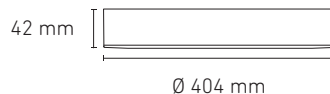

LUNA 45 FLAT S

CLAVE	W	V-	FP	Hz	TEMP. DE COLOR	lm	lm/W	IRC	COLOR	PESO	IP
L6376-1I0	45	100-305	≥0.9	50/60	4000K	4100	91	≥86	□	4,055 gr	IP 50
L6376-130					6000K						

Opcional atenuable

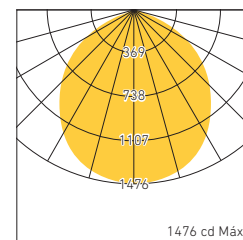
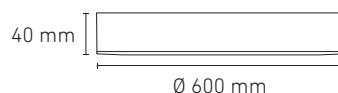

Categoría: DOWNLIGHTS

Familia: SERIE LUNA SQ FLAT SOBREPONER

SQ 9 FLAT S

CLAVE	W	V~	FP	Hz	TEMP. DE COLOR	lm	lm/W	IRC	COLOR	PESO	IP
L6367-1E0	9	100-240	>0.5	50/60	3000K	648	72	≥90	□	400 gr	IP 50
L6367-1I0					4000K	698	78				
L6367-130					6000K						

Opcional atenuable

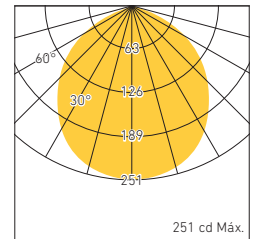
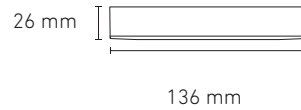

SQ 13 FLAT S

CLAVE	W	V~	FP	Hz	TEMP. DE COLOR	lm	lm/W	IRC	COLOR	PESO	IP
L6368-1E0	13	100-240	>0.5	50/60	3000K	1200	92	≥90	□	346 gr	IP 50
L6368-1I0					4000K						
L6368-130					6000K						

Opcional atenuable

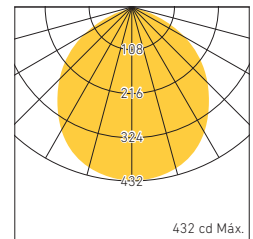
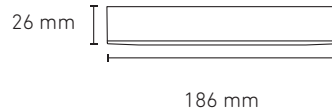

SQ 18 FLAT S

CLAVE	W	V~	FP	Hz	TEMP. DE COLOR	lm	lm/W	IRC	COLOR	PESO	IP
L6369-1E0	18	100-240	>0.5	50/60	3000K	1512	84	≥90	□	506 gr	IP 50
L6369-1I0					4000K						
L6369-130					6000K						

Opcional atenuable

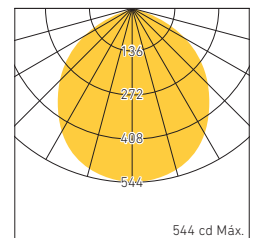
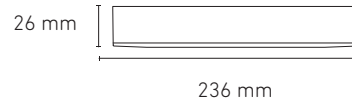
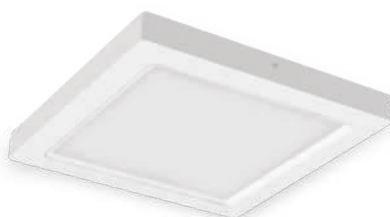

SQ 25 FLAT S

CLAVE	W	V-	FP	Hz	TEMP. DE COLOR	lm	lm/W	IRC	COLOR	PESO	IP
L6370-110	25	100-305	≥0.9	50/60	4000K	2300	92	≥90	□	1,100 gr	IP 50
L6370-130					6000K						

Opcional atenuable

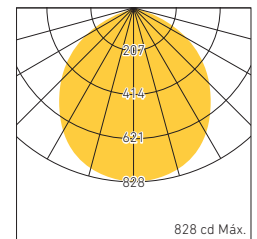
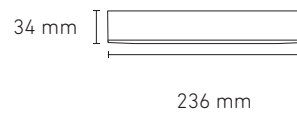
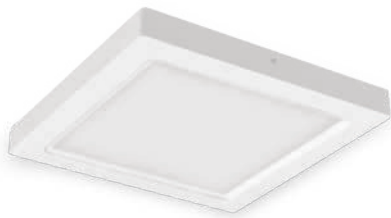

SQ 30 FLAT S

CLAVE	W	V-	FP	Hz	TEMP. DE COLOR	lm	lm/W	IRC	COLOR	PESO	IP
L6383-110	30	100-305	≥0.9	50/60	4000K	2500	83	≥86	□	3,270 gr	IP 50
L6383-130					6000K						

Opcional atenuable

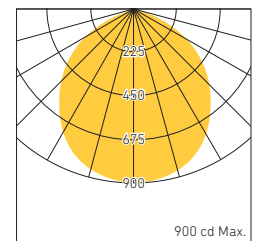
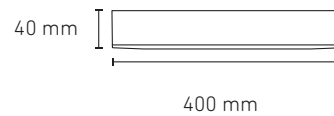

SQ 37 FLAT S

CLAVE	W	V-	FP	Hz	TEMP. DE COLOR	lm	lm/W	IRC	COLOR	PESO	IP
L6384-110	37	100-305	≥0.9	50/60	4000K	3340	90	≥86	□	3,500 gr	IP 50
L6384-130					6000K						

Opcional atenuable

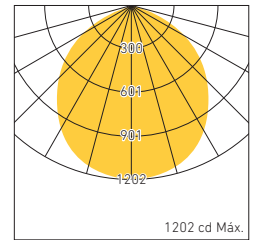
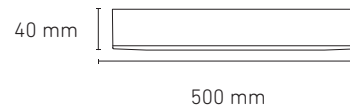

SQ 45 FLAT S

CLAVE	W	V-	FP	Hz	TEMP. DE COLOR	lm	lm/W	IRC	COLOR	PESO	IP
L6332-110	45	100-305	≥0.9	50/60	4000K	4100	91	≥86	□	4,700 gr	IP 50
L6332-130					6000K						

Opcional atenuable

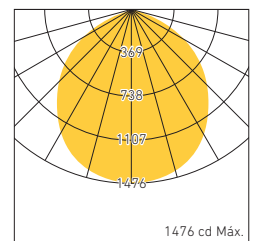
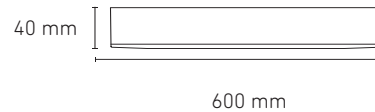

Categoría: DOWNLIGHTS

Familia: SERIE LUNA FLAT SUSPENDIDO

LUNA 35 FLAT S SUSPENDIDO

CLAVE	W	V-	FP	Hz	TEMP. DE COLOR	lm	lm/W	IRC	COLOR	PESO	IP
L6629-110	35	100-305	>0.9	50/60	4000K	3200	91	≥86	□	1,905 gr	IP 50
L6629-130					6000K						

Opcional atenuable

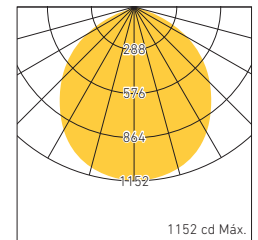
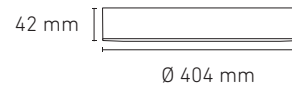

LUNA 45 FLAT S SUSPENDIDO

CLAVE	W	V-	FP	Hz	TEMP. DE COLOR	lm	lm/W	IRC	COLOR	PESO	IP
L6630-110	45	100-305	≥0.9	50/60	4000K	4100	91	≥86	□	4,055 gr	IP 50
L6630-130					6000K						

Opcional atenuable

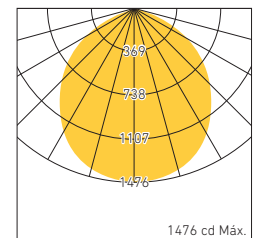
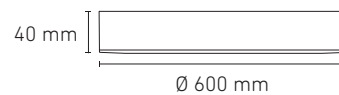

+

KIT DE SUSPENSIÓN

CLAVE	KIT DE SUSPENSIÓN
L6375-110	P3734-100
L6376-110	

LUNA 35 CG

LUNA 45 CG

(1.50 mts. de largo)

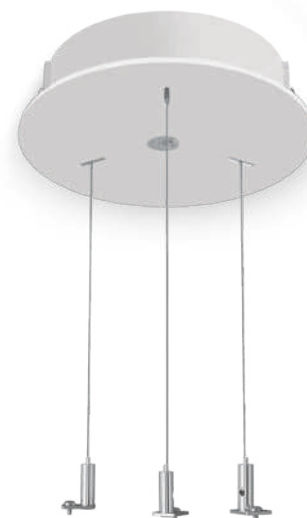



Por fase



Según
versión





S E R I E M

Downlight de tipo técnico, diseñado para iluminación general así como para iluminación puntual de alta calidad por su índice de reproducción cromática IRC ≥ 91 .

Su óptica tipo domo distribuye la luz de manera homogénea sin mostrar la fuente luminosa. Las ópticas tipo lente concentran la luz de forma uniforme y eficiente para aplicaciones de mayor altura de montaje.

Su gran variedad de tamaños y potencias hacen de la Serie M una familia de luminarias muy completa para cubrir necesidades de iluminación para prácticamente cualquier espacio y de cualquier dimensión.

Los drivers operan en el rango de tensión 100-305V. y son atenuables por fase, facilitan su instalación y operación.



Categoría: DOWNLIGHTS

Familia: SERIE M

M 500 LED

CLAVE	W	V~	FP	Hz		TEMP. DE COLOR	lm	lm/W	ÁNGULO	IRC	COLOR	PESO	IP
L5003-1I9	5	100-240	0.5	50/60	Por Fase*	4000K	425	85	45°	≥91	<input type="checkbox"/>	300 gr	IP 60
L5003-1E9						413	83						
L5003-BED						3000K	270	54	DOMO		<input type="checkbox"/>		
L5003-1ED											<input type="checkbox"/>		
L5003-BID						4000K	280	56			<input type="checkbox"/>		
L5003-1ID											<input type="checkbox"/>		

 70 mm

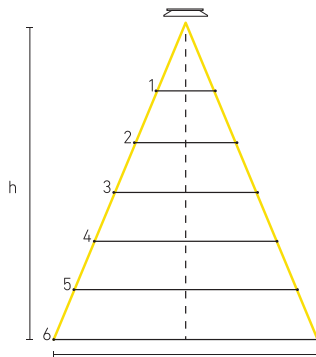
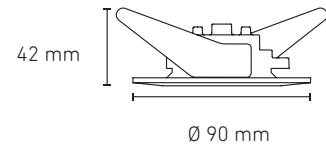

45°		
h (m)	d (m)	E (lx)
1	0.70	402
2	1.52	101
3	2.27	45
4	3.03	25
5	3.79	16

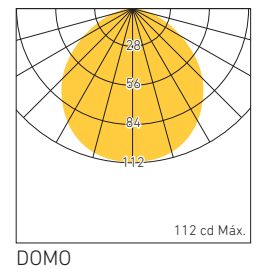
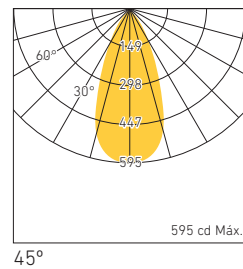

M 750 LED

CLAVE	W	V~	FP	Hz		TEMP. DE COLOR	lm	lm/W	ÁNGULO	IRC	COLOR	PESO	IP	
L5015-1E6	8	100-240	0.5	50/60	Por Fase*	3000K	440	73	20°	≥91	□	370 gr	IP 60	
L5015-1E9							685	86	45°					
L5015-1I6						4000K	590	74	20°					
L5015-1I9							695	87	45°					
L5015-BED						DOMO	3000K	460	64		DOMO			■
L5015-1ED								505	63					□
L5015-BID							4000K	485	61					■
L5015-1ID								515						□



100 mm

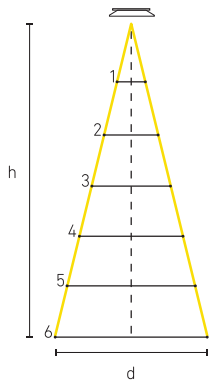
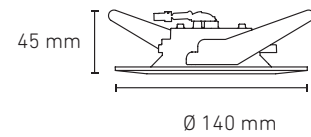

20°		
h (m)	d (m)	E (lx)
1	0.50	1240
2	1.00	323
3	1.50	145
4	2.01	82
5	2.51	53

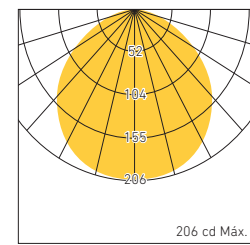

DOMO

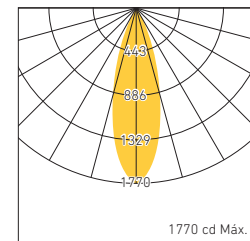

20°

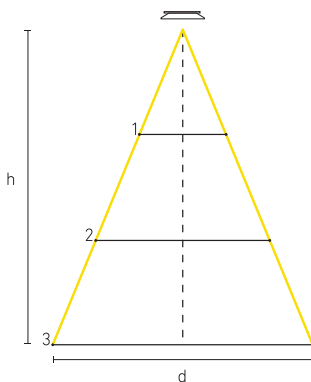

45°		
h (m)	d (m)	E (lx)
1	0.74	602
2	1.49	55
3	2.23	69

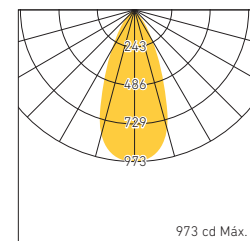

45°

M 1400 LED

CLAVE	W	V~	FP	Hz		TEMP. DE COLOR	lm	lm/W	ÁNGULO	IRC	COLOR	PESO	IP	
L5024-1E6	16	100-240	0.5	50/60	Por Fase	3000K	1230	77	20°	≥91	<input type="checkbox"/>	410 gr	IP 60	
L5024-1E9							1330	83	45°		<input type="checkbox"/>			
L5024-BE9									45°		<input checked="" type="checkbox"/>			
L5024-1I6						4000K	1290	80	20°		<input type="checkbox"/>			
L5024-1I9							1375	86	45°		<input type="checkbox"/>			
L5024-BI9									45°		<input checked="" type="checkbox"/>			
L5024-1ED						DOMO	3000K	1144	71		<input type="checkbox"/>			
L5024-BED								910	57					<input checked="" type="checkbox"/>
L5024-1ID							4000K	1180	74					<input type="checkbox"/>
L5024-BID								980	61					<input checked="" type="checkbox"/>



130 mm

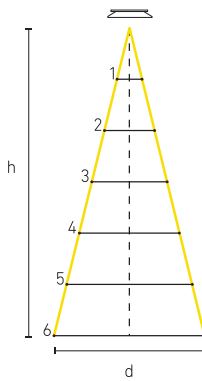
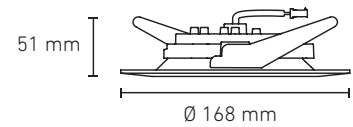

20°		
h (m)	d (m)	E (lx)
1	0.50	2021
2	1.00	530
3	1.50	238
4	2.00	134
5	2.51	86

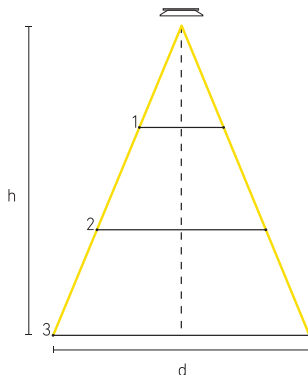
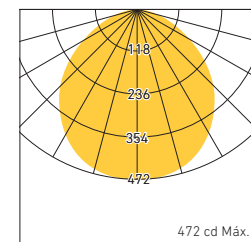
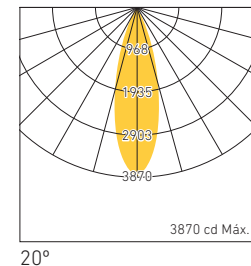

45°		
h (m)	d (m)	E (lx)
1	0.74	1110
2	1.49	282
3	2.23	126

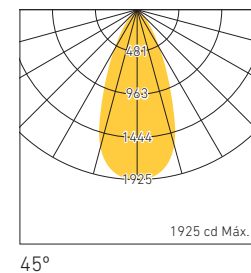

M 2300 LED

CLAVE	W	V-	FP	Hz	TEMP. DE COLOR	lm	lm/W	ÁNGULO	IRC	COLOR	PESO	IP
L5032-1E6	23	100-305	>0.9	50/60	3000K	2100	84	20°	≥91	□	1,467 gr	IP 60
L5032-1E9								45°				
L5032-1I6					4000K	2050	82	20°				
L5032-1I9								45°				
L5032-1ED					4000K	1850	74	DOMO				
L5032-1ID												

Opcional atenuable

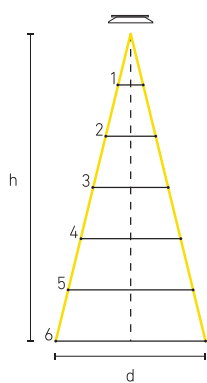
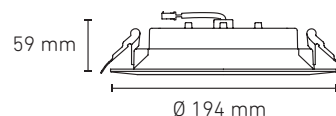

20°		
h (m)	d (m)	E (lx)
1	0.49	3627
2	0.97	955
3	1.46	429
4	1.95	243
5	2.44	156

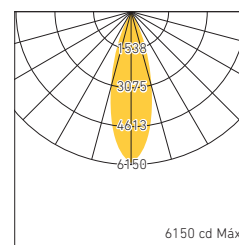

20°

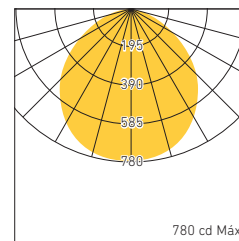

DOMO

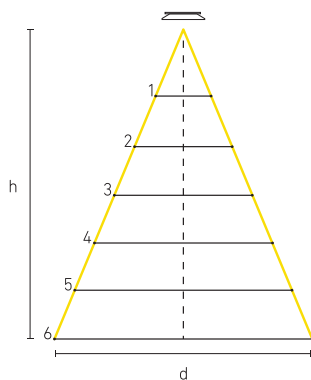

45°		
h (m)	d (m)	E (lx)
1	0.74	1719
2	1.48	439
3	2.23	196
4	2.97	111
5	3.71	71

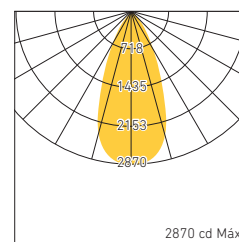

45°

M 3600 LED

CLAVE	W	V~	FP	Hz	TEMP. DE COLOR	lm	lm/W	ÁNGULO	IRC	COLOR	PESO	IP
L5040-1E6	37	100-305	>0.9	50/60	3000K	3200	80	30°	≥91	□	1,700 gr	IP 60
L5040-1E9					45°							
L5040-1I6					4000K	3400	85	30°				
L5040-1I9					4000K			45°				
L5040-1ED					3000K	3050	76	DOMO				
L5040-1ID					4000K	3200	80					

Opcional atenuable

 212 mm

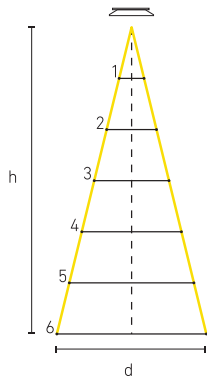
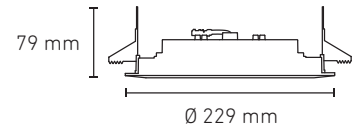

30°		
h (m)	d (m)	E (lx)
1	0.49	6016
2	0.97	1603
3	1.46	722
4	1.95	409
5	2.44	2063

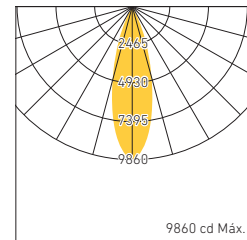

30°

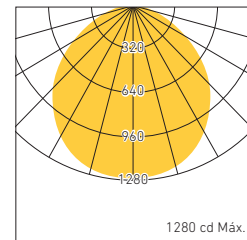

DOMO

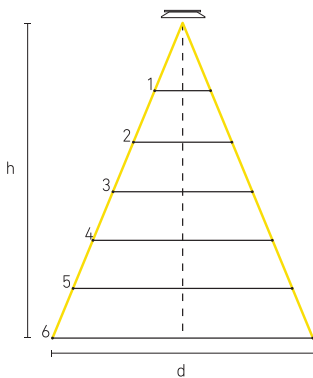

45°		
h (m)	d (m)	E (lx)
1	0.76	2849
2	1.52	729
3	2.25	327
4	3.84	184
5	3.75	118

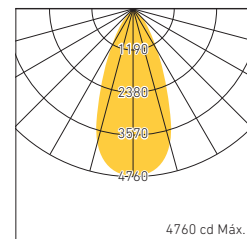

45°

M 7000 LED

CLAVE	W	V~	FP	Hz	TEMP. DE COLOR	lm	lm/W	ÁNGULO	IRC	COLOR	PESO	IP
L5050-1E5	80	100-305	>0.9	50/60	3000K	6480	81	24°	≥91	□	2,690 gr	IP 60
L5050-1I5					4000K	6600	82	24°				
L5050-1ID					4000K	6240	78	DOMO				

Opcional atenuable



260 mm

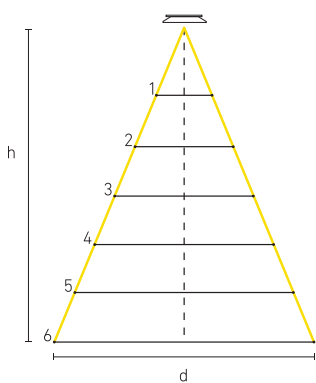
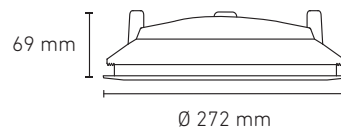

24°		
h (m)	d (m)	E (lx)
1	0.40	11161
2	0.81	3130
3	1.21	1421
4	1.62	810
5	2.02	522

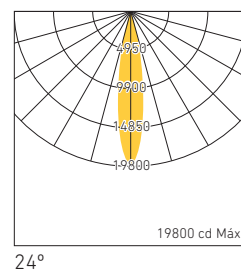

24°

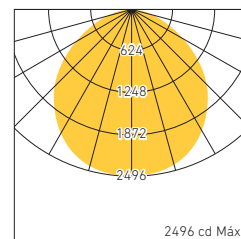

DOMO

Por su potencia y tamaño es ideal para marquesinas, dobles y triples alturas brindando una luz homogénea.



355°



15° - 25°

SERIE POINTS

Luminaria profunda direccionable con sistema cardánico, de alto confort visual, de forma ortogonal, que permite modular de manera sencilla las fuentes luminosas, se puede seleccionar desde 1 hasta 3 módulos para dirigirlos de manera individual con total flexibilidad. Su alto índice de reproducción cromática ≥ 90 le permiten resaltar los productos iluminados con muy alta calidad.

La claridad en su trazo hace de la familia Points una excelente opción para espacios dinámicos como exhibiciones, showrooms, tiendas departamentales, etc.



POINTS MICRO

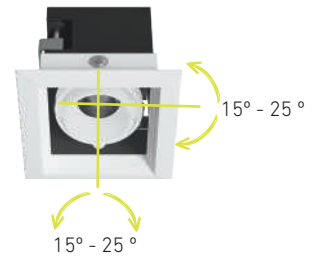

POINTS MICRO I

CLAVE	W	V~	FP	Hz	TEMP. DE COLOR	lm	lm/W	ÁNGULO	IRC	COLOR	PESO	IP			
L5914-YE4	4.5	100-240	0.5	50/60	3000K	225	50	20°	≥90	■	128 gr	IP 10			
L5914-YI4					4000K	245	54								
L5914-YEJ					3000K	235	52	40°							
L5914-YIJ													4000K	250	55
L5914-ZEJ															
L5914-ZIJ													4000K	250	55

Opcional atenuable



59X59 mm

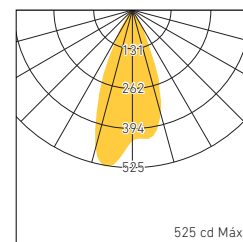
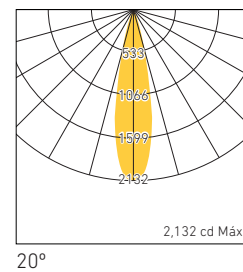
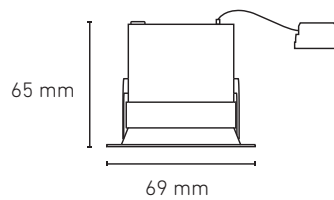

POINTS MICRO II

CLAVE	W	V~	FP	Hz	TEMP. DE COLOR	lm	lm/W	ÁNGULO	IRC	COLOR	PESO	IP	
L5915-YE4	9	100-240	0.5	50/60	3000K	2x230	52	20°	≥90	■	206 gr	IP 10	
L5915-YI4					4000K	2x245	54						
L5915-YEJ					3000K	2x235	52	40°					□
L5915-YIJ													
L5915-ZEJ													
L5915-ZIJ													

Opcional atenuable



 59X110 mm

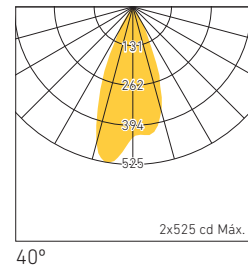
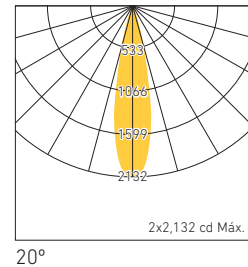
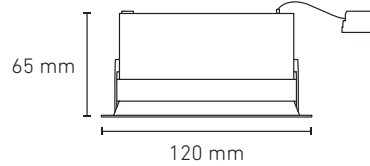

POINTS MICRO III

CLAVE	W	V~	FP	Hz	TEMP. DE COLOR	lm	lm/W	ÁNGULO	IRC	COLOR	PESO	IP	
L5916-YE4	12	100-240	0.5	50/60	3000K	3x230	58	20°	≥90	■	285 gr	IP 10	
L5916-YI4					4000K	3x260	65						
L5916-YEJ					3000K	3x230	58	40°					□
L5916-YIJ													
L5916-ZEJ													
L5916-ZIJ													

Opcional atenuable



 59X158 mm

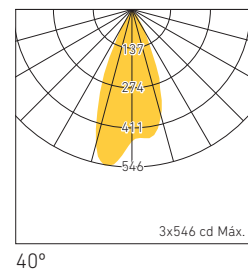
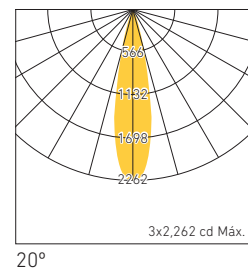
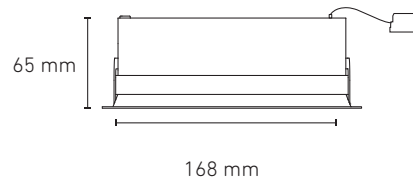

POINTS MINI

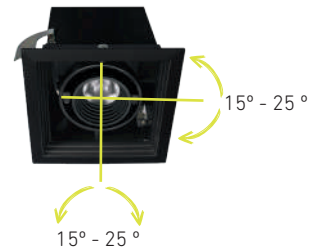

POINTS MINI I

CLAVE	W	V~	FP	Hz	TEMP. DE COLOR	lm	lm/W	ÁNGULO	IRC	COLOR	PESO	IP
L5905-YEK	8.8	100-240	0.5	50/60	3000K	625	71	15°	≥90	■	448 gr	IP 10
L5905-YIK					4000K	660	75					
L5905-YEL					3000K	625	71	25°				
L5905-YIL					4000K	660	75					

Opcional atenuable



105X105 mm

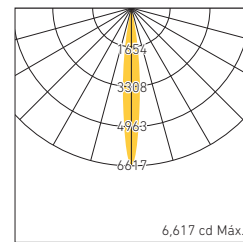
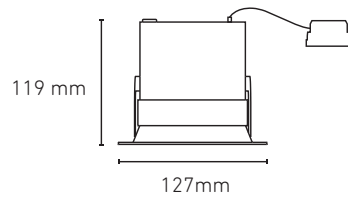

15°

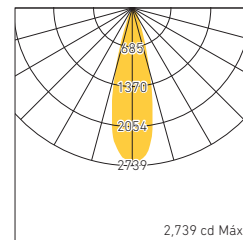

25°

POINTS MINI II

CLAVE	W	V~	FP	Hz	TEMP. DE COLOR	lm	lm/W	ÁNGULO	IRC	COLOR	PESO	IP
L5906-YEK	17	100-240	0.5	50/60	3000K	2x625	72	15°	≥90	■	718 gr	IP 10
L5906-YIK					4000K	2x660	77					
L5906-YEL					3000K	2x625	72	25°				
L5906-YIL					4000K	2x660	77					

Opcional atenuable



105X195 mm

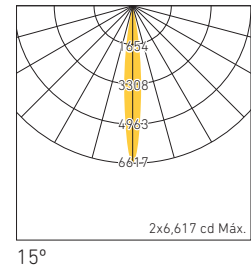
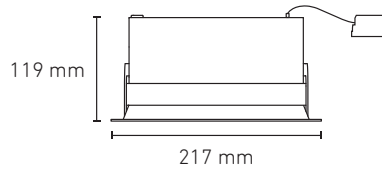

15°

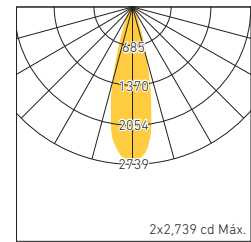

25°

POINTS MINI III

CLAVE	W	V~	FP	Hz	TEMP. DE COLOR	lm	lm/W	ÁNGULO	IRC	COLOR	PESO	IP
L5907-YEK	24.5	100-240	0.5	50/60	3000K	3x625	76	15°	≥90	■	992 gr	IP 10
L5907-YIK					4000K	3x660	80					
L5907-YEL					3000K	3x625	76	25°				
L5907-YIL					4000K	3x660	80					

Opcional atenuable



105X285 mm

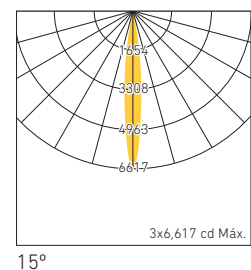
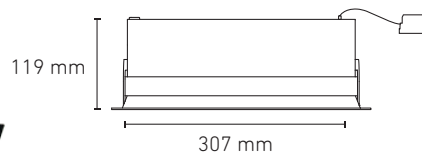

15°

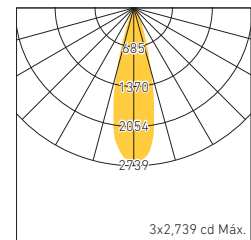

25°

POINTS MP

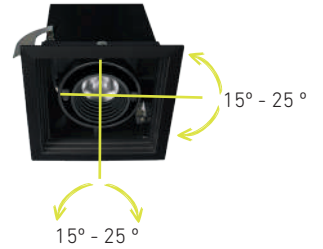

POINTS MP I

CLAVE	W	V-	FP	Hz	TEMP. DE COLOR	lm	lm/W	ÁNGULO	IRC	COLOR	PESO	IP
L5908-YEK	16	100-240	0.5	50/60	3000K	960	60	15°	≥90	■	656 gr	IP 10
L5908-YIK					4000K	1008	63					
L5908-YEL					3000K	960	60	25°				
L5908-YIL					4000K	1008	63					

Opcional atenuable



132X132 mm

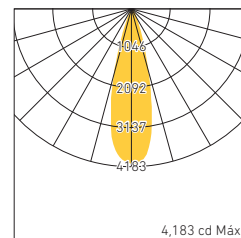
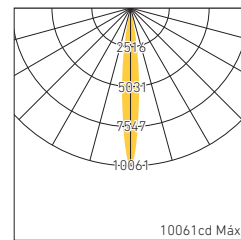
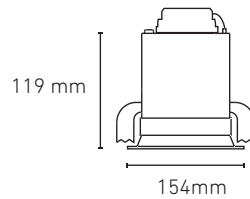

25°



POINTS MP II

CLAVE	W	V~	FP	Hz	TEMP. DE COLOR	lm	lm/W	ÁNGULO	IRC	COLOR	PESO	IP
L5909-YEK	30.5	100-240	>0.9	50/60	3000K	2x960	60	15°	≥90	■	1,075 gr	IP 10
L5909-YIK					4000K	2x1008	63					
L5909-YEL					3000K	2x960	60	25°				
L5909-YIL					4000K	2x1008	63					

Opcional atenuable

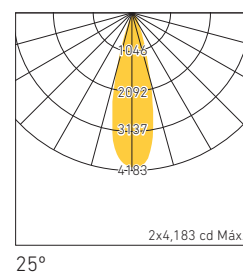
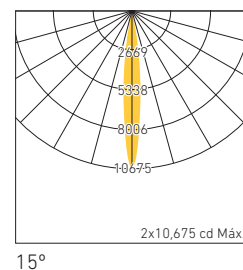
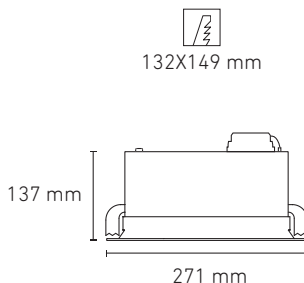

POINTS MP III

CLAVE	W	V~	FP	Hz	TEMP. DE COLOR	lm	lm/W	ÁNGULO	IRC	COLOR	PESO	IP
L5910-YEK	46.5	100-240	>0.9	50/60	3000K	3x960	60	15°	≥90	■	1,526 gr	IP 10
L5910-YIK					4000K	3x1008	63					
L5910-YEL					3000K	3x960	60	25°				
L5910-YIL					4000K	3x1008	63					

Opcional atenuable

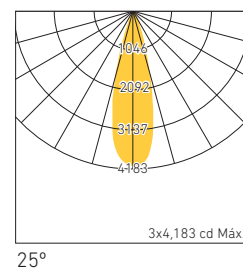
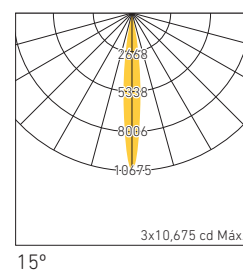
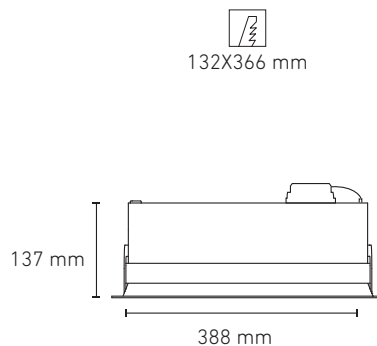

POINTS AP

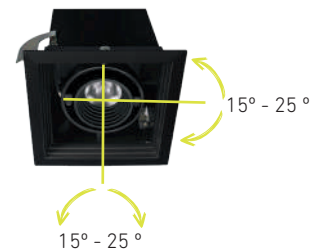

POINTS AP I

CLAVE	W	V~	FP	Hz	TEMP. DE COLOR	lm	lm/W	ÁNGULO	IRC	COLOR	PESO	IP
L5911-YEK	30.5	100-305	>0.9	50/60	3000K	2160	71	15°	≥90	■	675 gr	IP 10
L5911-YIK					4000K	2280	75					
L5911-YEL					3000K	2160	71	25°				
L5911-YIL					4000K	2280	75					

Opcional atenuable



136X136 mm

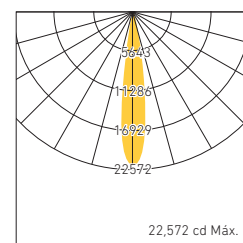

15°

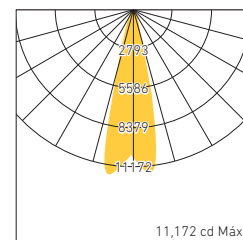
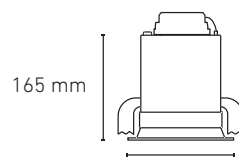

25°



POINTS AP II

CLAVE	W	V~	FP	Hz	TEMP. DE COLOR	lm	lm/W	ÁNGULO	IRC	COLOR	PESO	IP
L5912-YEK	61	100-305	>0.9	50/60	3000K	2x2160	71	15°	≥90	■	1,100 gr	IP 10
L5912-YIK					4000K	2x2280	75					
L5912-YEL					3000K	2x2160	71	25°				
L5912-YIL					4000K	2x2280	75					

Opcional atenuable



 136X290 mm

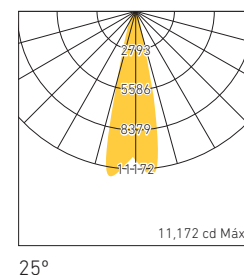
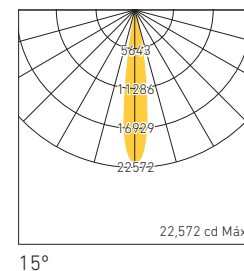
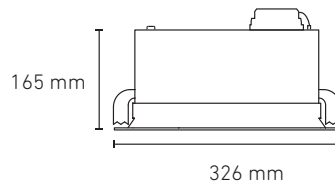

POINTS AP III

CLAVE	W	V~	FP	Hz	TEMP. DE COLOR	lm	lm/W	ÁNGULO	IRC	COLOR	PESO	IP
L5913-YEK	91.5	100-305	>0.9	50/60	3000K	3x2160	71	15°	≥90	■	1,050 gr	IP 10
L5913-YIK					4000K	3x2280	75					
L5913-YEL					3000K	3x2160	71	25°				
L5913-YIL					4000K	3x2280	75					

Opcional atenuable

 114X284 mm

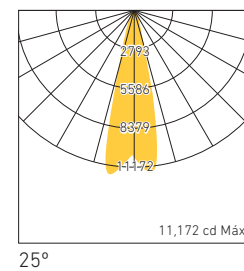
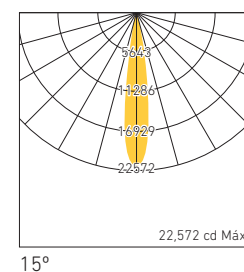
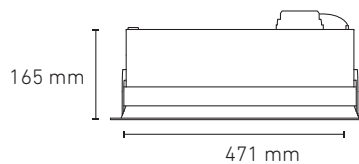



24° / 45°



20° / 40°



20°



S E R I E FLASH

Luminaria direccionable, de alto confort visual, de formas puras y elegantes con acabados que combinan o contrastan con su entorno, son una herramienta muy útil para el diseño de iluminación.

Ópticos montados en placas de 1 hasta 3 módulos para dirigirlos individualmente de manera flexible con ángulos de emisión de 20°, 24° y 40° Permite al diseñador iluminar puntualmente destacando de manera precisa los detalles arquitectónicos, los espacios o los productos.

Categoría: DOWNLIGHTS

Familia: SERIE FLASH

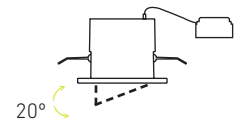

FLASH D I

CLAVE	W	V-	FP	Hz		TEMP. DE COLOR	lm	lm/W	ÁNGULO	IRC	COLOR	PESO	IP
L5175-1E4	4.4	100-240	0.5	50/60	Por Fase*	3000K	220	50	20°	≥82		114 gr	IP 60
L5175-YE4													
L5175-1EJ							40°						
L5175-YEJ													

*Opcional: Temperatura de color **4000K**

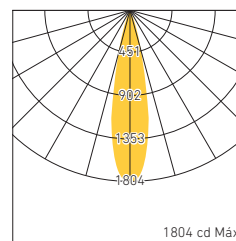
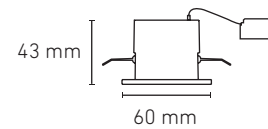

20°

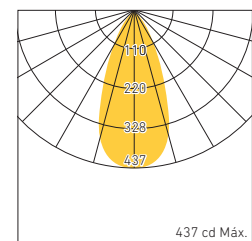

40°

FLASH D II

CLAVE	W	V~	FP	Hz		TEMP. DE COLOR	lm	lm/W	ÁNGULO	IRC	COLOR	PESO	IP
L5176-1E4	8.8	100-240	0.5	50/60	Por Fase*	3000K	440	50	20°	≥82	<input checked="" type="checkbox"/>	250 gr	IP 60
L5176-YE4									<input checked="" type="checkbox"/>				
L5176-1EJ							<input checked="" type="checkbox"/>						
L5176-YEJ							<input checked="" type="checkbox"/>						
							455	52	40°				

*Opcional: Temperatura de color **4000K**



50X122 mm

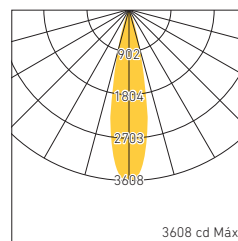
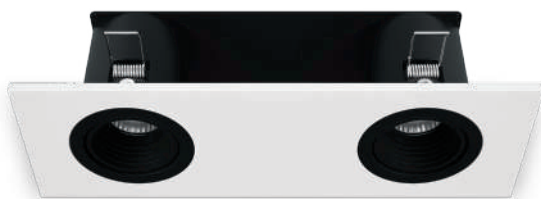
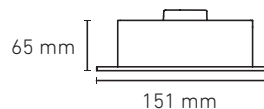

20°

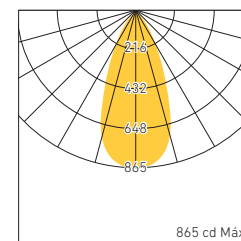

40°

FLASH D III

CLAVE	W	V~	FP	Hz		TEMP. DE COLOR	lm	lm/W	ÁNGULO	IRC	COLOR	PESO	IP
L5177-1E4	13	100-240	0.5	50/60	Por Fase*	3000K	660	50	20°	≥82	<input checked="" type="checkbox"/>	362 gr	IP 60
L5177-YE4									<input checked="" type="checkbox"/>				
L5177-1EJ							<input checked="" type="checkbox"/>						
L5177-YEJ							<input checked="" type="checkbox"/>						
							675	55	40°				

*Opcional: Temperatura de color **4000K**



50X202 mm

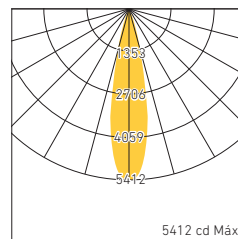
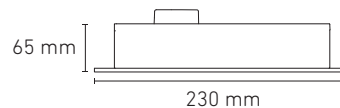

20°

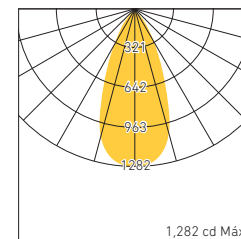

40°

Categoría: DOWNLIGHTS
 Familia: SERIE FLASH PLANO

FLASH I PLANO

CLAVE	W	V-	FP	Hz	TEMP. DE COLOR	lm	lm/W	ÁNGULO	IRC	COLOR	PESO	IP
L5143-EE5	3.5	100-240	0.5	50/60	3000K	220	62	24°	≥82	■	113 gr	IP 60
L5143-EI5					4000K	240	68					

Opcional atenuable

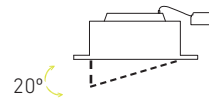
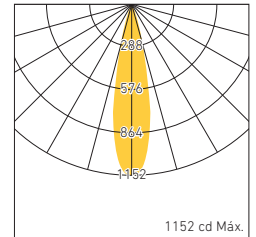
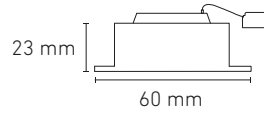

FLASH II PLANO

CLAVE	W	V-	FP	Hz	TEMP. DE COLOR	lm	lm/W	ÁNGULO	IRC	COLOR	PESO	IP
L5144-EE5	6	100-240	0.5	50/60	3000K	440	81	24°	≥82	■	170 gr	IP 60
L5144-EI5					4000K	480	89					

Opcional atenuable

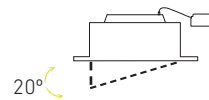
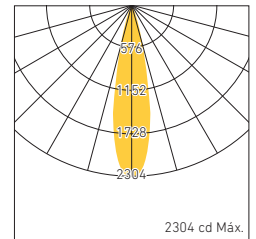
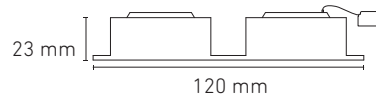

FLASH III PLANO

CLAVE	W	V-	FP	Hz	TEMP. DE COLOR	lm	lm/W	ÁNGULO	IRC	COLOR	PESO	IP
L5145-EE5	9	100-240	0.5	50/60	3000K	660	73	24°	≥82	■	256 gr	IP 60
L5145-EI5					4000K	720	80					

Opcional atenuable

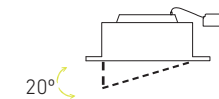
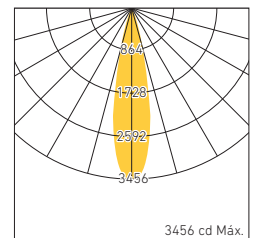
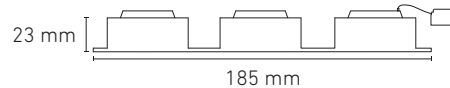

Categoría: DOWNLIGHTS

Familia: SOYUZ LED

SOYUZ LED

CLAVE	W	V-	FP	Hz	TEMP. DE COLOR	lm	lm/W	ÁNGULO	IRC	COLOR	PESO	IP
L6316-1E5	5	100-240	0.5	50/60	3000K	370	74	24°	≥91	□	95 gr	IP 60
L6316-1I5					4000K	380	76					

Opcional atenuable



73 mm

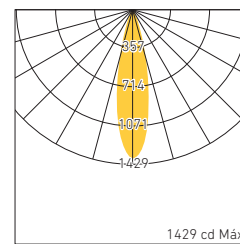
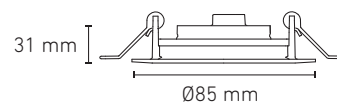

Rotación vertical 24°



+/- 30° Por eje



S E R I E ALPHA LED

Luminaria de formato modular integrada por un conjunto de arillos porta lámparas en formato circular y cuadrangular diseñado para alojar de 1 a 4 lámparas AR111 LED direccionable con sistema cardánico, de manera individual en dos ejes.

Cuenta con dos formas de instalación como: empotrar y suspender esto lo hace perfectamente aplicable a diversas circunstancias arquitectónicas.

ALPHA LED

LUMINARIA BASE

LÁMPARA

ALPHA ROUND LED*



ALPHA I LED*



ALPHA II LED*



ALPHA III LED*



ALPHA IV LED*



ALPHA
SUSPENDIDO II LED*



ALPHA
SUSPENDIDO III LED*



ALPHA
SUSPENDIDO IV L LED*



ALPHA
SUSPENDIDO IV LED*



+

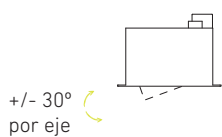

* No incluye lámpara, las luminarias se encuentran en la página 198.

ALPHA EMPOTRADO

ALPHA ROUND LED*

CLAVE	COLOR
L1733-100	□
L1733-300	■



165 mm

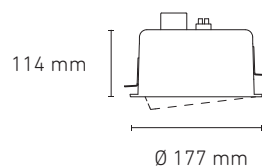

ALPHA I LED*

CLAVE	COLOR
L5901-100	□
L5901-300	■



160X160 mm

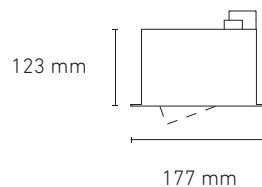

ALPHA II LED*

CLAVE	COLOR
L5902-100	□
L5902-300	■



320X160 mm

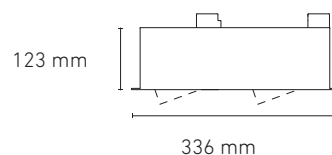

ALPHA III LED*

CLAVE	COLOR
L5903-100	□
L5903-300	■



475X160 mm

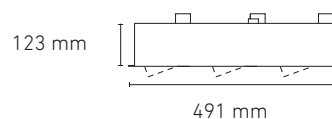

ALPHA IV LED*

CLAVE	COLOR
L5904-100	□
L5904-300	■



320X320 mm

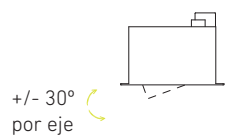
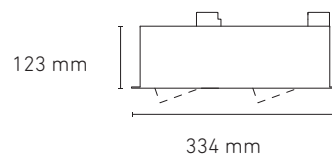

* Transformador incluido.

ALPHA SUSPENDIDO II LED*

CLAVE	COLOR
L5820-100	□
L5820-300	■

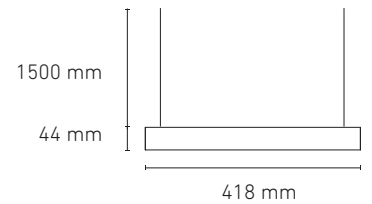

ALPHA SUSPENDIDO III LED*

CLAVE	COLOR
L5821-100	□
L5821-300	■

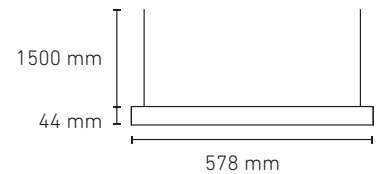

ALPHA SUSPENDIDO IV L LED*

CLAVE	COLOR
L5823-100	□
L5823-300	■

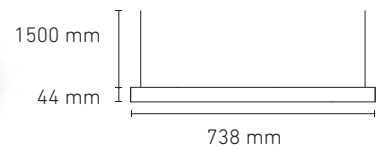

ALPHA SUSPENDIDO IV LED*

CLAVE	COLOR
L5822-100	□
L5822-300	■

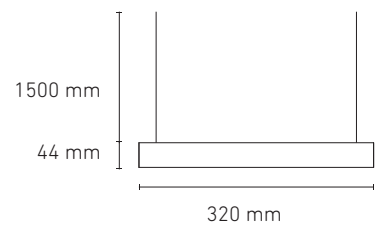

* No incluye lámpara, las luminarias se encuentran en la página 198.

* Transformador incluido.

ISIS I

CLAVE	COLOR	PESO
L5960-100	□	475 gr
L5960-300	■	



100X100 mm

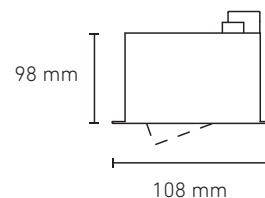

ISIS II

CLAVE	COLOR	PESO
L5961-100	□	850 gr
L5961-300	■	



195X100 mm

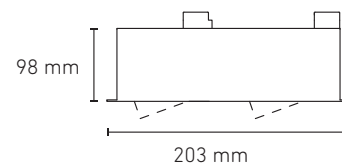

ISIS III

CLAVE	COLOR	PESO
L5962-100	□	1,235 gr
L5962-300	■	



285X100 mm

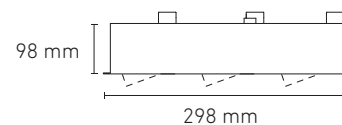

ISIS PIN HOLE

ISIS PIN HOLE I

CLAVE	COLOR	PESO
L5963-100	□	434 gr
L5963-300	■	



100X100 mm

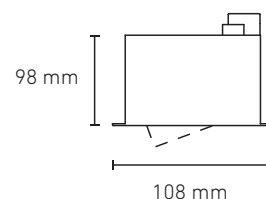

ISIS PIN HOLE II

CLAVE	COLOR	PESO
L5964-100	□	495 gr
L5964-300	■	



195X100 mm

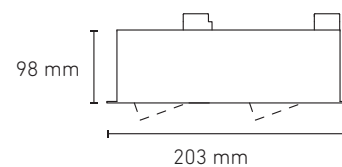

* Transformador y lámpara, no incluidos.

PROYECTORES

PÁGINA

SERIE C

SOBREPONER



SERIE C-S

C 12-S

C 20-S

C 30-S

..... 70-71

EMPOTRAR



SERIE C-E

C 12-E

C 20-E

C 30-E

..... 72-73

A RIEL



SERIE C-R

C 12-R

C 20-R

C 30-R

..... 74-75

SLASH

EMPOTRADOS



SLASH LED

SLASH MINI

..... 78

ALPHA



ALPHA LED A RIEL

ALPHA LED A CANOPE

..... 79

SWING



SWING 38 R

SWING 38 S

..... 80

OFICINAS

CUBIC LED

EMPOTRAR



CUBIC LED 60X60

CUBIC LED 60X120

..... 84

CUBIC SOFT

EMPOTRAR



CUBIC SOFT 60X60

CUBIC SOFT 60X120

..... 85

CUBIC SOFT DEEP

EMPOTRAR



CUBIC SOFT 60X60 CUBIC SOFT 60X120

PÁGINA

86

SERIE PANEL

EMPOTRAR/
SUSPENDER
PANEL BÁSICO



PANEL BÁSICO 60X60 PANEL BÁSICO 60X120

87

EMPOTRAR/
SUSPENDER
PANEL STD



PANEL STD 60X60 PANEL STD 60X120 PANEL STD 30X120 PANEL PRIME 20X120 PANEL PRIME15X120 ..

88-89

EMPOTRAR/
SUSPENDER
PANEL PRIME



PANEL PRIME 60X60 PANEL PRIME 60X120 PANEL STD 30X120

90

KROMOS LED

EMPOTRAR



KROMOS LED 60X60 KROMOS LED 60X120

91

SISTEMA LINEAL BLU

BLU



BLU EMPOTRAR BLU SOBREPONER BLU SUSPENDER

94-95

BLU MINI



BLU MINI EMPOTRRAR

96

TREK

SUSPENDER



TREK 900 TREK 1200 TREK 1800

97



24° / 45°



355°



160°



PROYECTORES SERIE C

Diseño sencillo y elegante, altamente flexible por sus 3 sistemas de montaje; C-S Sobrepuesto, C-E Empotrado y C-R Riel.

Por su sistema cardánico de haz de luz direccionable en dos ejes y su confort visual, la Serie C permite generar atmósferas de alto contraste para enfatizar elementos arquitectónicos, cuadros, esculturas, islas comerciales con la confianza de contar con un alto índice de reproducción cromática en temperaturas de color cálida y neutra.

Serie C es una herramienta poderosa de diseño de iluminación adecuada para cualquier tipo de ambiente y escala.



Categoría: PROYECTORES

Familia: SERIE C

C-S

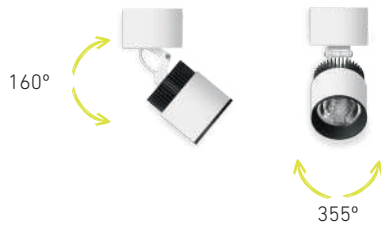

C 12-S

CLAVE	W	V-	FP	Hz	TEMP. DE COLOR	lm	lm/W	ÁNGULO	IRC	COLOR	PESO	IP
L5668-1E5	12	100-240	>0.9	50/60	3000K	830	69	24°	≥82	□	320 gr	IP 40
L5668-3E5										■		
L5668-1E9								□				
L5668-3E9								■				
L5668-1I5					4000K	880	73	24°		□		
L5668-3I5										■		
L5668-1I9								□				
L5668-3I9								■				

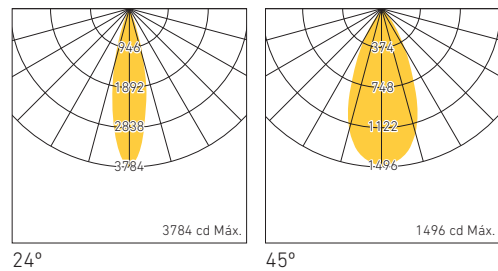
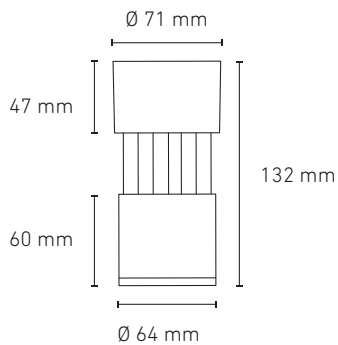

C 20-S

CLAVE	W	V~	FP	Hz	TEMP. DE COLOR	lm	lm/W	ÁNGULO	IRC	COLOR	PESO	IP
L5666-1E5	20	100-305	>0.9	50/60	3000K	1440	72	24°	≥82	□	715 gr	IP 40
L5666-3E5								■				
L5666-1E9								□				
L5666-3E9								■				
L5666-1I5					□							
L5666-3I5					■							
L5666-1I9					□							
L5666-3I9					■							
					4000K	1500	75	24°				
								45°				

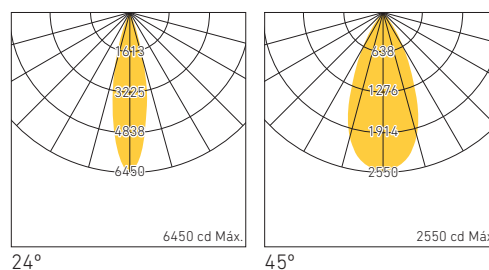
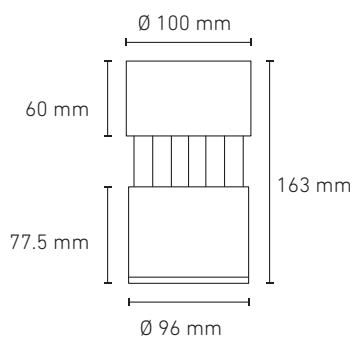

C 30-S

CLAVE	W	V~	FP	Hz	TEMP. DE COLOR	lm	lm/W	ÁNGULO	IRC	COLOR	PESO	IP
L5667-1E5	29	100-305	>0.9	50/60	3000K	2400	83	24°	≥82	□	925 gr	IP 40
L5667-3E5								■				
L5667-1E9								□				
L5667-3E9								■				
L5667-1I5					□							
L5667-3I5					■							
L5667-1I9					□							
L5667-3I9					■							
					4000K	2450	84	24°				
								45°				

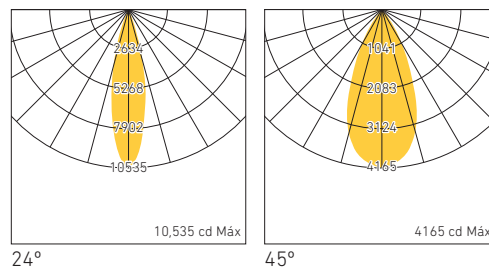
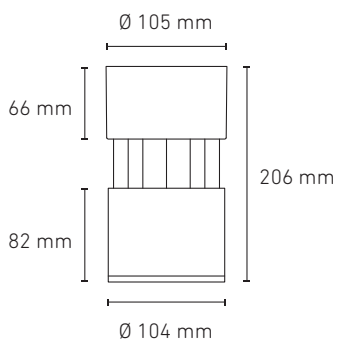

C-E



C 12-E

CLAVE	W	V-	FP	Hz	TEMP. DE COLOR	lm	lm/W	ÁNGULO	IRC	COLOR	PESO	IP
L5670-1E5	12	100-240	>0.9	50/60	3000K	830	69	24°	≥82	□	645 gr	IP 40
L5670-3E5								■				
L5670-1E9								□				
L5670-3E9								■				
L5670-1I5					4000K	880	73	24°		□		
L5670-3I5								■				
L5670-1I9								□				
L5670-3I9								■				



95 mm

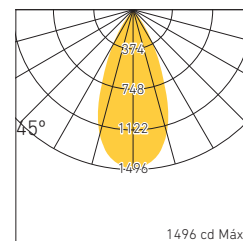
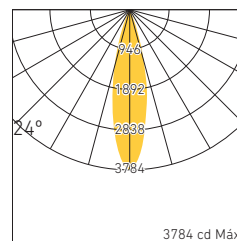
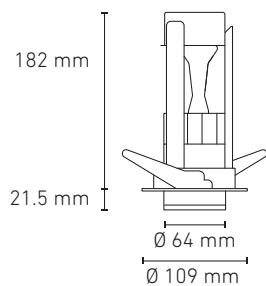

C 20-E

CLAVE	W	V-	FP	Hz	TEMP. DE COLOR	lm	lm/W	ÁNGULO	IRC	COLOR	PESO	IP
L5671-1E5	20	100-305	>0.9	50/60	3000K	1440	72	24°	≥82	□	920 gr	IP 40
L5671-3E5								■				
L5671-1E9								□				
L5671-3E9								■				
L5671-1I5					□							
L5671-3I5					■							
L5671-1I9					□							
L5671-3I9					■							

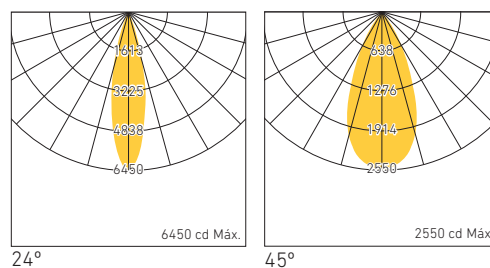
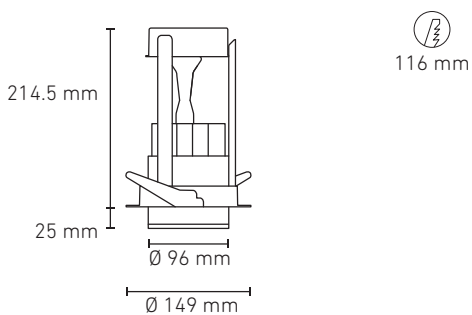

C 30-E

CLAVE	W	V-	FP	Hz	TEMP. DE COLOR	lm	lm/W	ÁNGULO	IRC	COLOR	PESO	IP
L5672-1E5	29	100-305	>0.9	50/60	3000K	2400	83	24°	≥82	□	1,260 gr	IP 40
L5672-3E5								■				
L5672-1E9								□				
L5672-3E9								■				
L5672-1I5					□							
L5672-3I5					■							
L5672-1I9					□							
L5672-3I9					■							

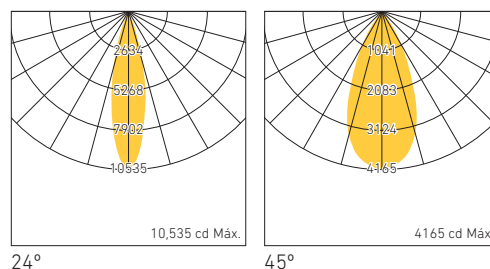
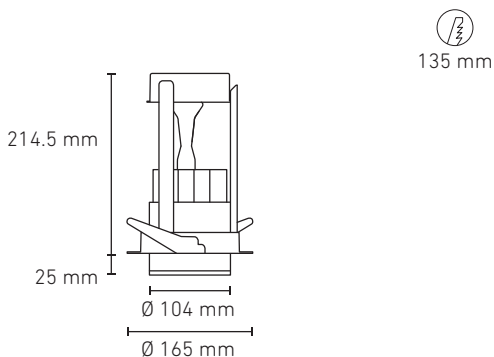

C-R

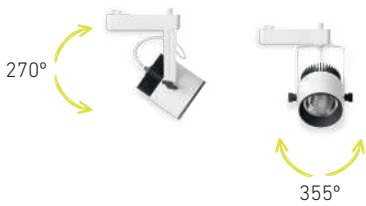

C 12-R

CLAVE	W	V~	FP	Hz	TEMP. DE COLOR	lm	lm/W	ÁNGULO	IRC	COLOR	PESO	IP
L5662-1E5	12	100-240	>0.9	50/60	3000K	830	69	24°	≥82	<input type="checkbox"/>	380 gr	IP 40
L5662-3E5								■				
L5662-1E9								45°		<input type="checkbox"/>		
L5662-3E9								■				
L5662-1I5					4000K	880	73	24°		<input type="checkbox"/>		
L5662-3I5								■				
L5662-1I9								45°		<input type="checkbox"/>		
L5662-3I9								■				

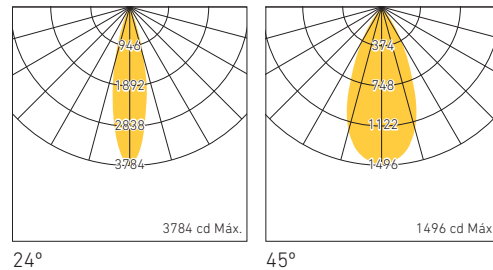
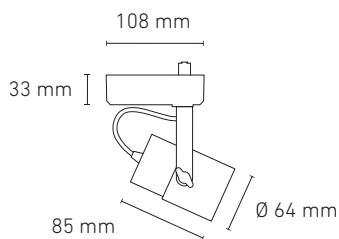

C 20-R

CLAVE	W	V-	FP	Hz	TEMP. DE COLOR	lm	lm/W	ÁNGULO	IRC	COLOR	PESO	IP
L5660-1E5	21	100-305	>0.9	50/60	3000K	1440	72	24°	≥82	<input type="checkbox"/>	805 gr	IP 40
L5660-3E5								<input type="checkbox"/>				
L5660-1E9								<input type="checkbox"/>				
L5660-3E9								<input type="checkbox"/>				
L5660-1I5					4000K	1500	75	24°		<input type="checkbox"/>		
L5660-3I5								<input type="checkbox"/>				
L5660-1I9								<input type="checkbox"/>				
L5660-3I9								<input type="checkbox"/>				

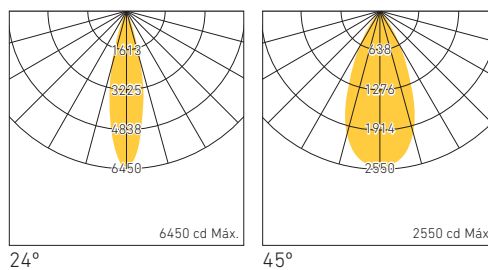
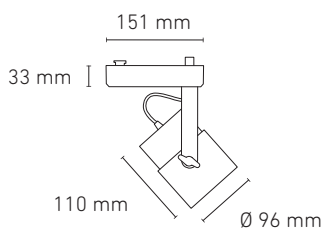

C 30-R

CLAVE	W	V-	FP	Hz	TEMP. DE COLOR	lm	lm/W	ÁNGULO	IRC	COLOR	PESO	IP
L5661-1E5	29	100-305	>0.9	50/60	3000K	2400	83	24°	≥82	<input type="checkbox"/>	925 gr	IP 40
L5661-3E5								<input type="checkbox"/>				
L5661-1E9								<input type="checkbox"/>				
L5661-3E9								<input type="checkbox"/>				
L5661-1I5					4000K	2450	84	24°		<input type="checkbox"/>		
L5661-3I5								<input type="checkbox"/>				
L5661-1I9								<input type="checkbox"/>				
L5661-3I9								<input type="checkbox"/>				

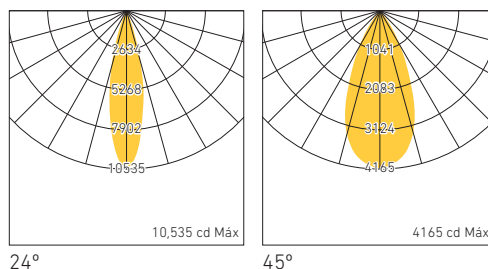
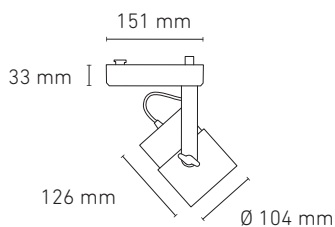



Control
0-10V



24° / 50°



355°



60°



S E R I E SLASH

La iluminación comercial debe contar con altos índices de reproducción cromática, para poder resaltar los mejores atributos, formas y colores. Abarcar grandes áreas con pocas fuentes de iluminación, a su vez mantener una imagen neutral en la estética de las luminarias para lograr una mejor integración con la arquitectura moderna. Slash y Slash mini son luminarias tanto dirigibles como orientables en dos de sus ejes, haciendo de ésta familia la mejor opción, muy discreta, flexible, potente y confortable visualmente.

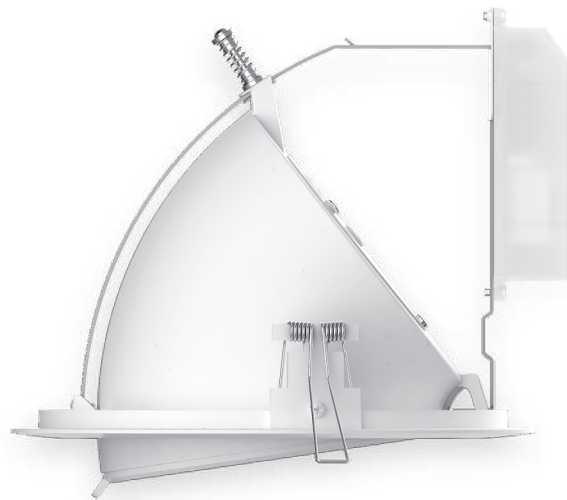

Categoría: PROYECTORES
 Familia: SERIE SLASH

SLASH LED

CLAVE	W	V~	FP	Hz	TEMP. DE COLOR	lm	lm/W	ÁNGULO	IRC	COLOR	PESO	IP
L5060-1E5	25	100-240	≥0.9	50/60	3000K	1550	62	24°	≥93	■	1,340 gr	IP 60
55°												
4000K					1700	68	24°	≥93				
							55°					



180 mm

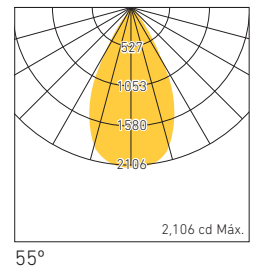
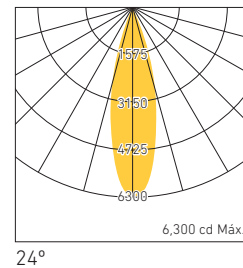
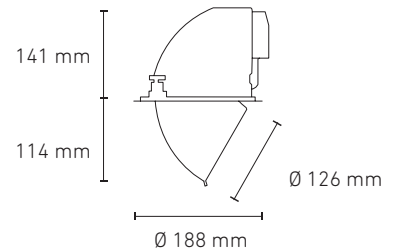

SLASH MINI

CLAVE	W	V~	FP	Hz	■ ■ ■	TEMP. DE COLOR	lm	lm/W	ÁNGULO	IRC	COLOR	PESO	IP
L6398-1EL	8.8	100-305	>0.5	50/60	0-10V	3000K	760	87	25°	≥82	□	1,340 gr	IP 60
L6398-1IL						4000K	790	90					
L6398-1EF						3000K	660	75	50°				
L6398-1IF													



102 mm

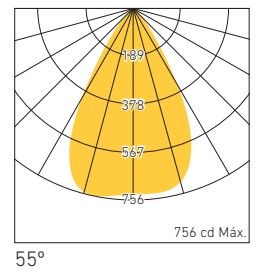
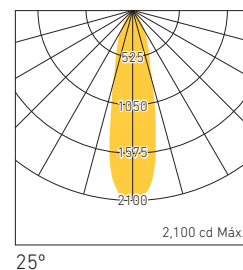
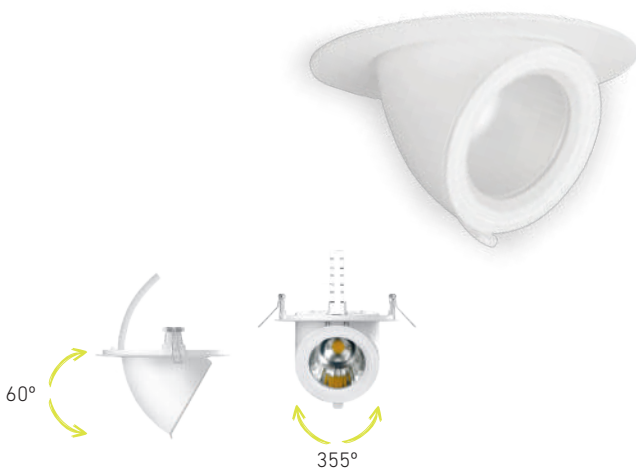
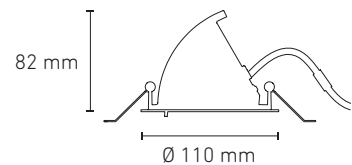

ALPHA A RIEL LED

CLAVE	COLOR	PESO
L5641-100	□	410 gr
L5641-300	■	

*No incluye lámpara.

IP50

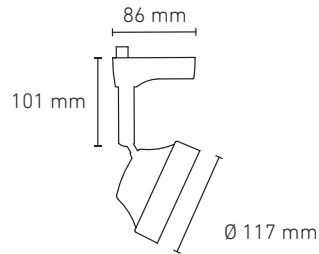

ALPHA A CÁNOPE LED

CLAVE	COLOR	PESO
L5645-100	□	410 gr
L5645-300	■	

*No incluye lámpara.

IP50

+

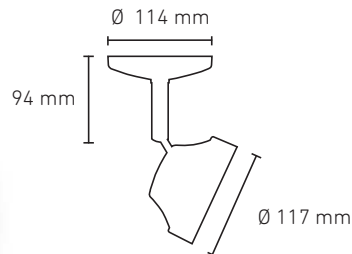

Categoría: PROYECTORES
 Familia: SERIE SWING 38

SWING 38 R

CLAVE	COLOR	PESO
L1832-100	□	305 gr
L1832-300	■	

*No incluye lámpara.

IP60

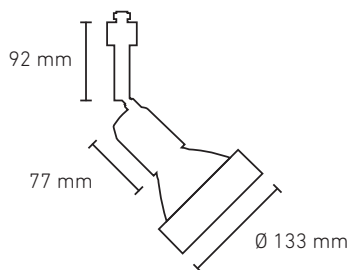

SWING 38 S

CLAVE	COLOR	PESO
L1842-100	□	550 gr
L1842-300	■	

*No incluye lámpara.

IP60

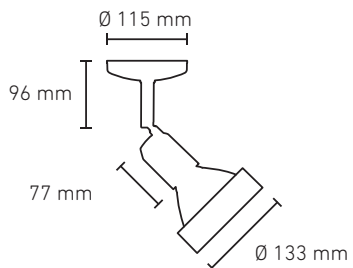





OFFICE

La línea de luminarias para OFICINA de Magg, abarcan soluciones modulares para integrarse perfectamente en plafones reticulares así como en plafones lisos haciendo destacar los espacios abiertos o privados de oficinas y permitiendo lograr condiciones perfectas de luz general para trabajo. Aunado a las soluciones para empotrar existen las opciones para suspender con la misma apariencia ligera dando un toque de modernidad indiscutible.

Categoría: OFICINA
 Familia: CUBIC LED

CUBIC LED 60X60

CLAVE	W	V-	FP	Hz	TEMP. DE COLOR	lm	lm/W	IRC	COLOR	PESO	IP
L5511-110	31	100-305	>0.9	50/60	4000K	3700	119	≥82	□	3,325 gr	IP 50
L5511-130					6000K						

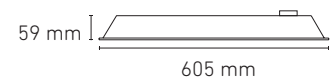
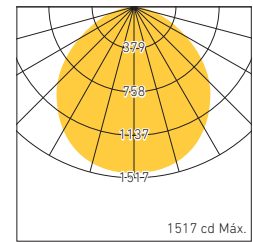

CUBIC LED 60X120

CLAVE	W	V-	FP	Hz	TEMP. DE COLOR	lm	lm/W	IRC	COLOR	PESO	IP
L5512-110	60	100-240	>0.9	50/60	4000K	6900	115	≥82	□	6,500 gr	IP 50
L5512-130					6000K						

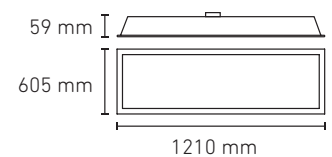
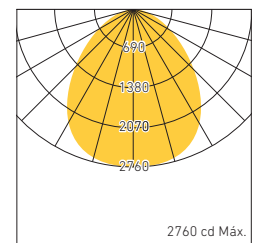
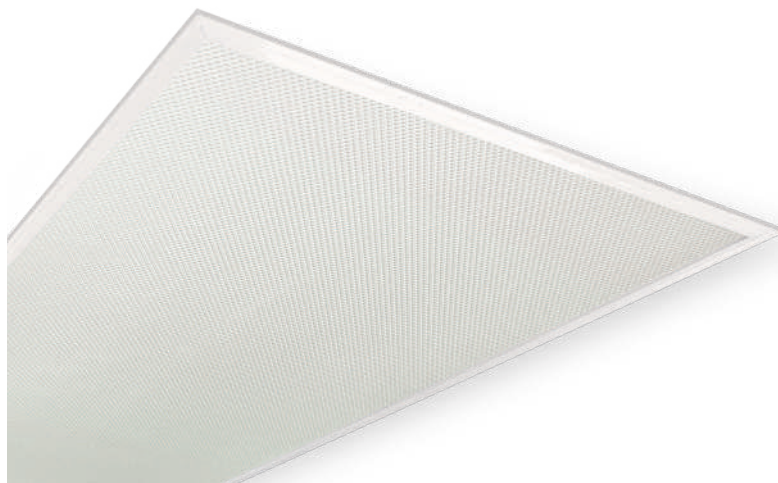

Categoría: OFICINA
 Familia: CUBIC SOFT

CUBIC SOFT 60X60

CLAVE	W	V-	FP	Hz	TEMP. DE COLOR	lm	lm/W	IRC	COLOR	PESO	IP
L5554-110	31	100-305	>0.9	50/60	4000K	3300	106	≥82	□	2,280 gr	IP 50
L5554-130					6000K						

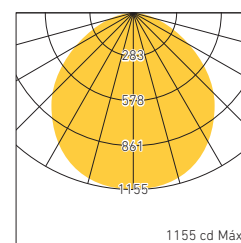

CUBIC SOFT 60X120

CLAVE	W	V-	FP	Hz	TEMP. DE COLOR	lm	lm/W	IRC	COLOR	PESO	IP
L5555-110	60	100-240	>0.9	50/60	4000K	6820	110	≥82	□	6,700 gr	IP 50
L5555-130					6000K						

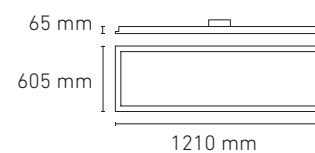
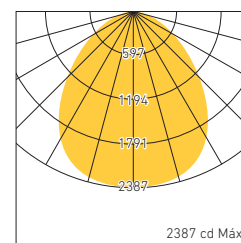

CUBIC SOFT DEEP 60X60

CLAVE	W	V-	FP	Hz	TEMP. DE COLOR	lm	lm/W	IRC	COLOR	PESO	IP
L6082-110	31	100-305	>0.9	50/60	4000K	3300	106	≥82	□	2,280 gr	IP 50
L6082-130					6000K						

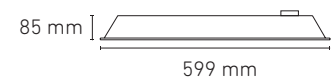
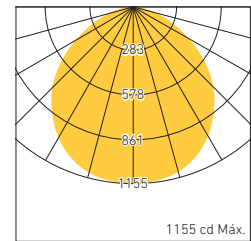

CUBIC SOFT DEEP 60X120

CLAVE	W	V-	FP	Hz	TEMP. DE COLOR	lm	lm/W	IRC	COLOR	PESO	IP
L6083-110	60	100-240	>0.9	50/60	4000K	6820	110	≥82	□	6,700 gr	IP 50
L6083-130					6000K						

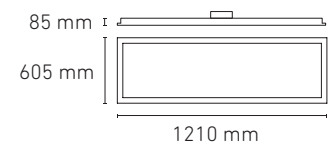
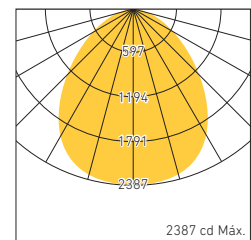

<u>FAMILIA PANEL</u>	<u>VIDA</u>	<u>RECOMENDACIÓN</u>
PANEL BÁSICO	20,000 hrs	1 a 30 Luminarios
PANEL ESTANDAR	40,000 hrs	> 30 Luminarios
PANEL PRIME	50,000 hrs	

PANEL BÁSICO

PANEL BÁSICO 60X60 EMPOTRAR / SUSPENDER

CLAVE	W	V~	FP	Hz	THD	TEMP. DE COLOR	lm	lm/W	IRC	COLOR	PESO	IP
L5571-110	32	100-140	0.5	50/60	125%	4000K	2900	88	≥74	■	3,630 gr	IP 50
L5571-130						6000K						

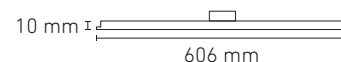
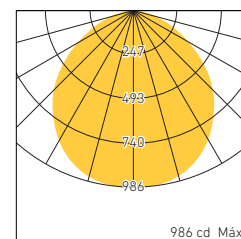

PANEL BÁSICO 60X120 EMPOTRAR / SUSPENDER

CLAVE	W	V~	FP	Hz	THD	TEMP. DE COLOR	lm	lm/W	IRC	COLOR	PESO	IP
L5592-110	64	100-140	0.5	50/60	125%	4000K	5600	87	≥74	□	4900 gr.	IP 50
L5592-130						6000K						

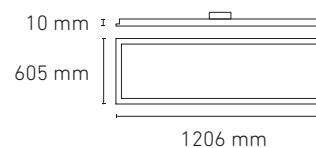
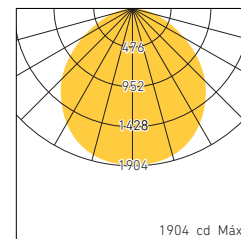

PANEL ESTANDAR

PANEL STD 60X60 EMPOTRAR / SUSPENDER

CLAVE	W	V~	FP	Hz	TEMP. DE COLOR	lm	lm/W	IRC	COLOR	PESO	IP
L5520-1E0	33	100-240	>0.9	50/60	3000K	3200	90	≥82	□	3,630 gr	IP 50
L5520-1I0					4000K	3300	94				
L5520-130					6000K						

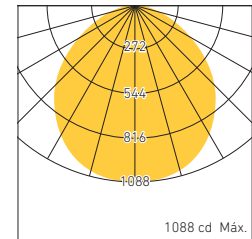
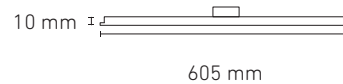

PANEL STD 60X120 EMPOTRAR / SUSPENDER

CLAVE	W	V~	FP	Hz	TEMP. DE COLOR	lm	lm/W	IRC	COLOR	PESO	IP
L5521-1E0	64	100-240	>0.9	50/60	3000K	6350	94	≥82	□	4,900 gr	IP 50
L5521-1I0					4000K	6600	97				
L5521-130					6000K						

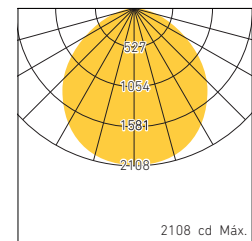
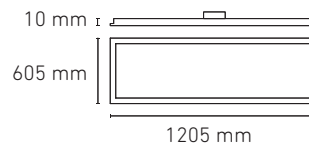

PANEL STD 30X120 EMPOTRAR / SUSPENDER

CLAVE	W	V~	FP	Hz	TEMP. DE COLOR	lm	lm/W	IRC	COLOR	PESO	IP
L5523-1E0	34	100-240	>0.9	50/60	3000K	3200	90	≥82	□	4,400 gr	IP 50
L5523-1I0					4000K	3300	94				
L5523-130					6000K						

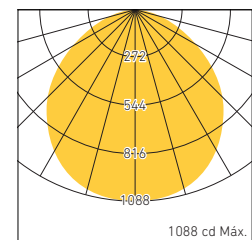
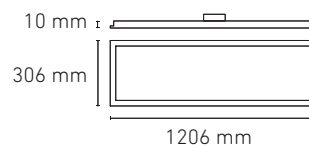

PANEL STD 20X120 EMPOTRAR / SUSPENDER

CLAVE	W	V~	FP	Hz	TEMP. DE COLOR	lm	lm/W	IRC	COLOR	PESO	IP
L5526-1E0	30	100-240	>0.9	50/60	3000K	2250	75	≥82	□	3,035 gr	IP 50
L5526-110					4000K	2400	80				
L5526-130					6000K						

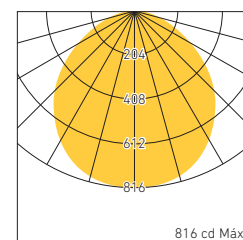
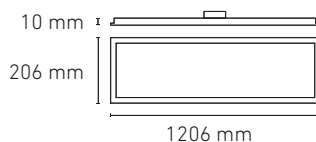

PANEL STD 15X120 EMPOTRAR / SUSPENDER

CLAVE	W	V~	FP	Hz	TEMP. DE COLOR	lm	lm/W	IRC	COLOR	PESO	IP
L5524-1E0	18	100-240	>0.9	50/60	3000K	1800	100	≥82	□	2,640 gr	IP 50
L5524-110					4000K						
L5524-130					6000K						

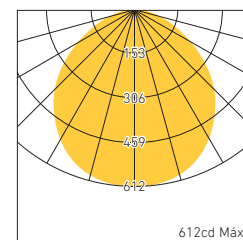
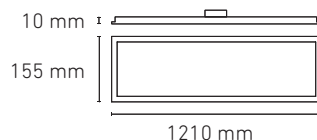

*Este producto es atenuable control 0-10V es sobre pedido.

KITS DE SUSPENSIÓN QUE APLICA A LA SERIE PANEL

KIT DE SUSPENSIÓN	CLAVE
60X60	P3789-000
60X120	P3787-000
20X120	P3791-000
30X120	P3790-000
15X120	P3792-000

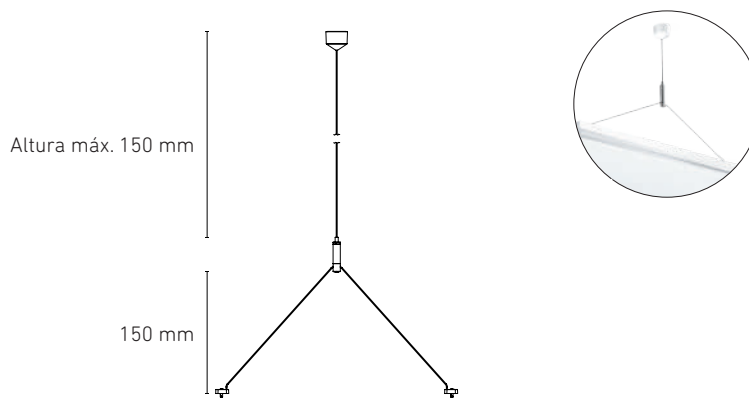

PRIME

PANEL PRIME 60X60 EMPOTRAR / SUSPENDER

CLAVE	W	V~	FP	Hz	COLOR	lm	lm/W	IRC	COLOR	PESO	IP
L6052-1E0	33	100-305	>0.9	50/60	3000K	3100	94	≥90	☐	3,630 gr.	IP 50
L6052-1I0					4000K	3300	100				
L6052-130					6000K						

*Este producto es atenuable control 0-10V es sobre pedido.

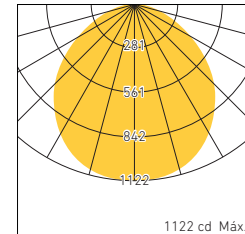
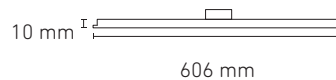

Referencia a 4000K

PANEL PRIME 60X120 EMPOTRAR / SUSPENDER

CLAVE	W	V~	FP	Hz	COLOR	lm	lm/W	IRC	COLOR	PESO	IP
L6053-1E0	64	100-305	>0.9	50/60	3000K	6020	94	≥90	☐	4,900 gr.	IP 50
L6053-1I0					4000K	6400	100				
L6053-130					6000K						

*Este producto es atenuable control 0-10V es sobre pedido.

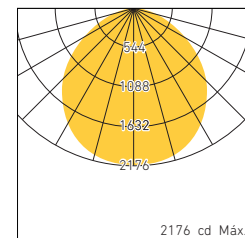
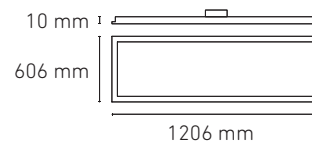

Referencia a 4000K

PANEL PRIME 30X120 EMPOTRAR / SUSPENDER

CLAVE	W	V~	FP	Hz	COLOR	lm	lm/W	IRC	COLOR	PESO	IP
L6054-1E0	33	100-305	>0.9	50/60	3000K	3100	94	≥90	☐	4,400 gr.	IP 50
L6054-1I0					4000K	3300	100				
L6054-130					6000K						

*Este producto es atenuable control 0-10V es sobre pedido.

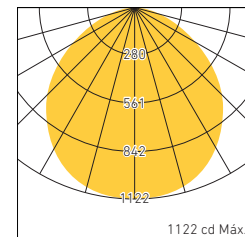
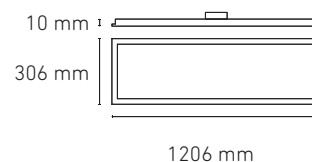

Referencia a 4000K

Categoría: OFICINA
 Familia: KROMOS LED

KROMOS LED 60X60 EMPOTRAR

CLAVE	W	V~	FP	Hz	TEMP. DE COLOR	lm	lm/W	IRC	COLOR	PESO	IP
L6033-110	3x9	100-140	0.5	50/60	4000K	2400	89	≥82	□	3,715 gr	IP 10
L6033-130					6000K						

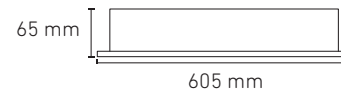
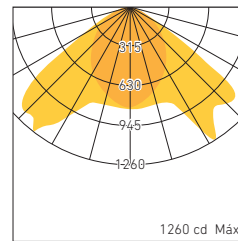

KROMOS LED 60X120 EMPOTRAR

CLAVE	W	V~	FP	Hz	TEMP. DE COLOR	lm	lm/W	IRC	COLOR	PESO	IP
L6034-110	3x18	100-140	>0.9	50/60	4000K	4800	89	≥82	□	6,000 gr	IP 10
L6034-130					6000K						

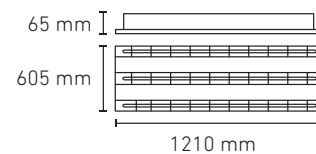
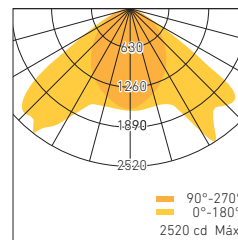





SERIES --- BL U y BL U MINI

La posibilidad de solucionar de manera integral un proyecto con sistemas de iluminación diferentes y con las mas comunes formas de instalación, a su vez determinar un solo sistema que responda estas necesidades, es en sí un gran reto.

Contar con luminarias empotrados, sobrepuestos y suspendidos, todos con una misma imagen con la posibilidad de resolver diferentes zonas de un mismo proyecto. Contar con accesorios para dar continuidad a las líneas que se quieran formar. Todos estos puntos se resuelven de manera exitosa con la familia BL U Y BL U mini.

Sistema de iluminación en formato lineal diseñado para crear líneas continuas de luz homogénea sin mostrar la fuente de luz para iluminación general. En dos tamaños de ancho de emisión de luz, 46mm. en BL U y 30mm. en BL U mini.

BL U y BL U mini nos ofrecen ahorros en instalación y mantenimiento por su diseño de reflector tipo regleta que integra los componentes electrónicos para poder ser instalados o reemplazados de manera práctica y fácil.



Además de contar con drivers multi voltaje 100-305V que facilitan su utilización en cualquier instalación eléctrica.

Categoría: OFICINA
 Familia: SISTEMA LINEAL BL U

BL U EMPOTRAR

CLAVE	TAMAÑO	W	V-	FP	Hz	TEMP. DE COLOR	lm	lm/W	IRC	Piezas máx. interconexión	COLOR	PESO	IP
L6471-1E0	1200	23	100-305	>0.9	50/60	3000K	1748	76	>82	13	□	1,700 gr	IP 30
L6471-1I0						4000K	1840	80					
L6472-1E0	2400	46				3000K	3500	76		6		3,200 gr	
L6472-1I0						4000K	3680	80					

Opcional: También en diferentes potencias, temperaturas de color e índices de reproducción cromática.

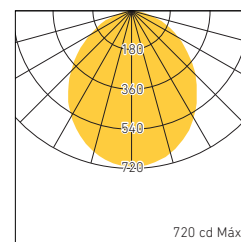
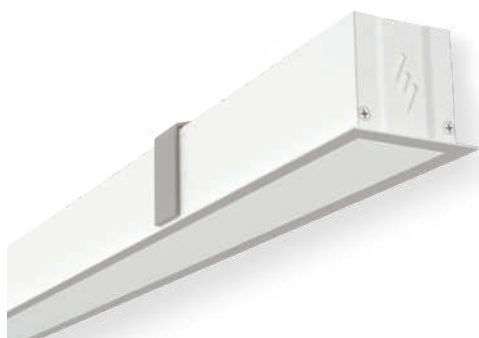

 1192X60 mm 2396X60 mm

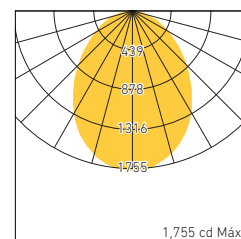

1200



2400

BL U SOBREPONER

CLAVE	TAMAÑO	W	V-	FP	Hz	TEMP. DE COLOR	lm	lm/W	IRC	Piezas máx. interconexión	COLOR	PESO	IP
L6477-1E0	1200	23	100-305	>0.9	50/60	3000K	1748	76	>82	13	□	1,700 gr	IP 30
L6477-1I0						4000K	1840	80					
L6478-1E0	2400	46				3000K	3496	76		6		3,200 gr	
L6478-1I0						4000K	3680	80					

Opcional: También en diferentes potencias, temperaturas de color e índices de reproducción cromática.

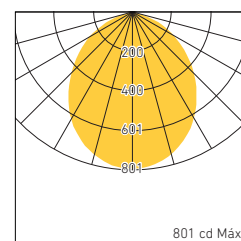
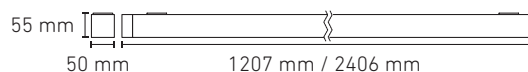

1200

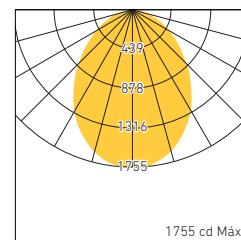

2400

BL U SUSPENDER

CLAVE	TAMAÑO	W	V-	FP	Hz	TEMP. DE COLOR	lm	lm/W	IRC	Piezas máx. inter-conexión	COLOR	PESO	IP
L6474-1E0	1200	23	100-305	>0.9	50/60	3000K	1500	65	>82	13	□	1,700 gr	IP 30
L6474-1I0						4000K	1600	70					
L6475-1E0	2400	46				3000K	3000	65		6		3,200 gr	
L6475-1I0						4000K	3200	70					

Opcional: También en diferentes potencias, temperaturas de color e índices de reproducción cromática.

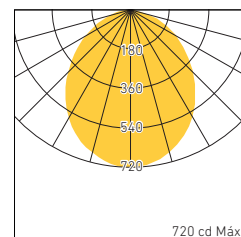
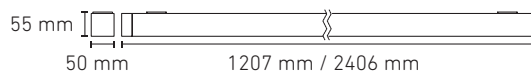

1200

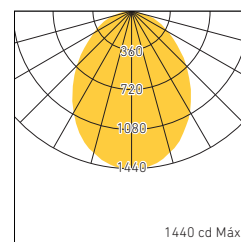

2400

BL U 30W

CLAVE	TAMAÑO	W	V-	FP	Hz	TEMP. DE COLOR	lm	lm/W	IRC	Piezas máx. inter-conexión	COLOR	PESO	IP
L6551-1I0	1200	30	100-305	>0.9	50/60	4000K	2340	78	>82	10	□	1,700 gr	IP 30
L6552-1I0													
L6553-1I0													
L6551-130						6000K	2400	80					
L6552-130													
L6553-130													

BL U 60W

CLAVE	TAMAÑO	W	V-	FP	Hz	TEMP. DE COLOR	lm	lm/W	IRC	Piezas máx. inter-conexión	COLOR	PESO	IP
L6554-1I0	2400	60	100-305	>0.9	50/60	4000K	4680	78	>82	5	□	3,200 gr	IP 30
L6555-1I0													
L6556-1I0													
L6554-130						6000K	4800	80					
L6555-130													
L6556-130													

Categoría: OFICINA
 Familia: SISTEMA LINEAL BL U MINI

BL U MINI EMPOTRAR

CLAVE	TAMAÑO	W	V~	THD	FP	Hz	TEMP. DE COLOR	lm	lm/W	IRC	Piezas máx. interconexión	COLOR	PESO	IP
L6548-1E0	1200	23	100-305	18%	>0.9	50/60	3000K	2070	90	>82	13	□	1370 gr	IP 30
L6548-110							4000K	2140	93					
L6549-1E0	2400	46					3000K	4140	90		6		2690 gr	
L6549-110							4000K	4280	93					

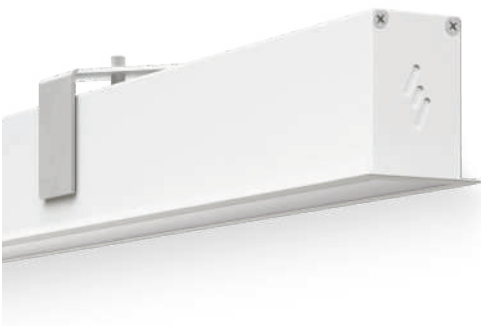

 1202X35 mm /  2402X35 mm

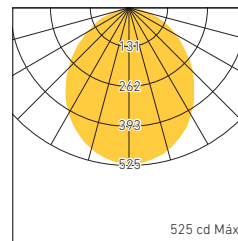
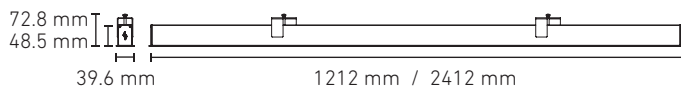

1200

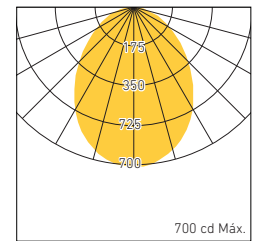

2400

Categoría: OFICINA

Familia: TREK

TREK 900

CLAVE	W	V~	FP	Hz	TEMP. DE COLOR	lm	lm/W	IRC	COLOR	PESO	IP
L5833-1E0	45	100-240	0.5	50/60	3000K	3900	87	≥82	□	1,850 gr	IP 50
L5833-3E0						3375	75		■		
L5833-1I0					4000K	4170	93		□		
L5833-3I0						3639	81		■		

TREK 1200

CLAVE	W	V~	FP	Hz	TEMP. DE COLOR	lm	lm/W	IRC	COLOR	PESO	IP
L5830-1E0	60	100-240	0.5	50/60	3000K	6500	108	≥82	□	2,000 gr	IP 50
L5830-3E0						5160	86		■		
L5830-1I0					4000K	6900	115		□		
L5830-3I0						5350	89		■		

TREK 1800

CLAVE	W	V~	FP	Hz	TEMP. DE COLOR	lm	lm/W	IRC	COLOR	PESO	IP
L5831-1E0	90	100-240	0.5	50/60	3000K	8790	98	≥82	□	2,960 gr	IP 50
L5831-3E0						7500	83		■		
L5831-1I0					4000K	9300	103		□		
L5831-3I0						8400	93		■		

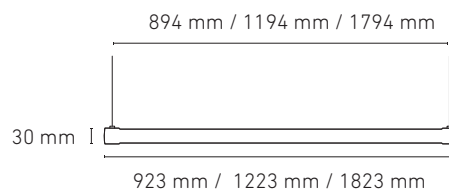
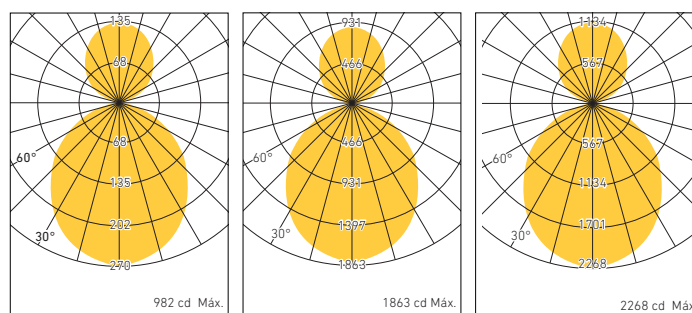

INDUSTRIAL / COMERCIAL

LUMINARIAS SELLADAS IP65 SOBREPONER

PÁGINA

GAMMA T8 LED



GAMMA LED T8

103

GAMMA LED 600



GAMMA LED 600

103

GAMMA 1200



GAMMA LED 1200 S



GAMMA LED 1200 M CORTA



GAMMA LED 1200 HO CORTA



GAMMA LED 1200 HO CORTA SS

104-105

GAMMA 1800



GAMMA LED 1800 M LARGA



GAMMA LED 1800 HO LARGA

106

GAMMA TOT



GAMMA TOT 600



GAMMA TOT 1200



GAMMA TOT 1500

107

GAMMA AUTOATENUABLE



GAMMA LED 1200 S



GAMMA LED 1200 M

108

GAMMA CON SISTEMA DE EMERGENCIA



GAMMA LED 600



GAMMA LED 1200 S

PÁGINA

109

GAMMA CON SENSOR DE MOVIMIENTO



GAMMA LED 600



GAMMA LED 1200 S



GAMMA LED 1200 M CORTA

110-111

CAMPANAS ACRÍLICO SOBREPONER



CAMPANA 12/20



CAMPANA 14/30



CAMPANA 14/50



CAMPANA 14/80

114-115

GABINETES METÁLICOS SOBREPONER



TRACK LED



TRACK WAVE LED



MINI TRACK T8 LED



GÉMINIS MINI T8 LED

118-119

SERIE HIGHBAY SUSPENDER



HIGHBAY 100



HIGH BAY 150



HIGH BAY 200



HIGH BAY 300

122-123





S E R I E GAMMA

En los temas industriales encontramos una luminaria básica, esta luminaria tipo estanco ha resultado ser con el tiempo, la imagen general de los estacionamientos, bodegas, áreas de servicio, etc.

La serie GAMMA se distingue por su diseño hermético, por su eficiencia energética que nos da rendimientos desde 98 lm/W hasta 126 lm/W., además de su amplia oferta de difusores claros y opalinos que nos dan distintas apariencias para una amplia variedad y tipo de espacios.

Otras variantes de la Serie Gamma integran sistemas autoatenuables, sistemas con sensor de movimiento y sistemas de emergencia, así como diseños más esbeltos, para las distintas circunstancias a resolver.

GAMMA LED

- El sello de silicón garantiza un cierre absoluto a lo largo de la vida del mismo en ambientes externos.

- Cuerpo de luminaria a prueba de agua

- Sistema de LED con driver integrado para operar a 100-305 vca 50/60 hz.

- Aislamiento térmico y amortiguación mecánica de vibración.

- Apertura y cierre con mucha facilidad

- Incluye accesorios para sobreponer.



GAMMA LED T8

CLAVE	W	V-	FP	Hz	TEMP. DE COLOR	lm	lm/W	IRC	PANTALLA	PESO	IP
L5479-510	2X16	100-240	0.5	50/60	4000K	3150	98	≥70	Transparente	3,100 gr	IP 65
L5479-530					6000K						
L5489-510					4000K	3680	116		Texturizado		
L5489-530					6000K						

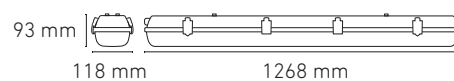
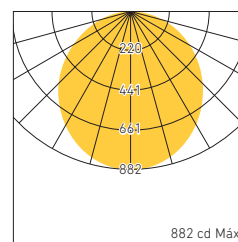

GAMMA LED 600

CLAVE	W	V-	FP	Hz	TEMP. DE COLOR	lm	lm/W	IRC	PANTALLA	PESO	IP
L5411-510	15	100-240	0.5	50/60	4000K	1670	111	≥82	Texturizado	1,180 gr	IP 65
L5411-530					6000K						

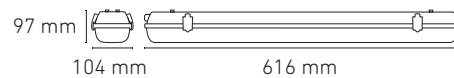
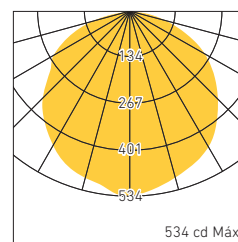

GAMMA 1200 S

GAMMA LED 1200 S

CLAVE	W	V~	FP	Hz	TEMP. DE COLOR	lm	lm/W	VERSIÓN	IRC	PANTALLA	PESO	IP
L5405-5I0	29	100-305	>0.9	50/60	4000K	3750	129	FIJO	≥82	Transparente	2,200 gr	IP 65
L5405-530					6000K							
L5401-530					4000K	3660	126			Texturizado		
L5401-5I0												

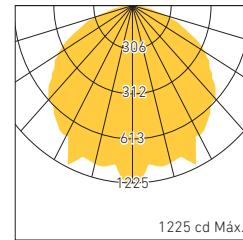

Transparente

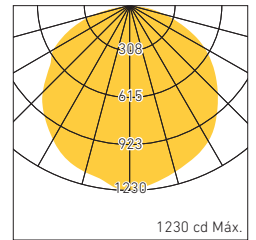

Texturizada

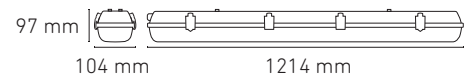

GAMMA LED 1200 M CORTA

CLAVE	W	V~	FP	Hz	TEMP. DE COLOR	lm	lm/W	VERSIÓN	IRC	PANTALLA	PESO	IP
L5417-5I0	50	100-240	>0.9	50/60	4000K	6100	120	FIJO	≥82	Transparente	2,400 gr	IP 65
L5417-530					6000K							
L5409-5I0					4000K	6100	120			Texturizado		
L5409-530												

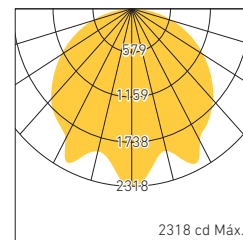

Transparente

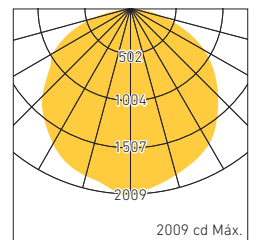

Texturizada

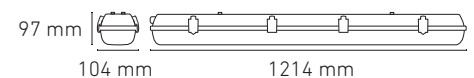

GAMMA LED 1200 HO CORTA

CLAVE	W	V~	FP	Hz	TEMP. DE COLOR	lm	lm/W	VERSIÓN	IRC	PANTALLA	PESO	IP
L5413-510	70	100-305	>0.9	50/60	4000K	8400	120	FIJO	≥82	Texturizado	2,540 gr	IP 65
L5413-530					6000K	8540	122					

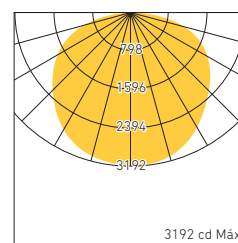

Texturizada

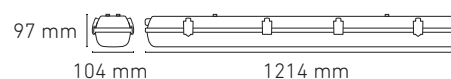

GAMMA LED 1200 HO CORTA SS

CLAVE	W	V~	FP	Hz	TEMP. DE COLOR	lm	lm/W	VERSIÓN	IRC	PANTALLA	PESO	IP
L5701-510	70	100-305	>0.9	50/60	4000K	8400	120	FIJO	≥82	Texturizado	2,540 gr	IP 65
L5701-530					6000K	8540	122					

- Broche de acero inoxidable

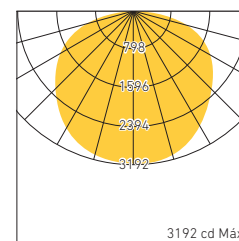

Texturizada

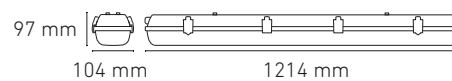

GAMMA LED 1800

GAMMA LED 1800 M LARGA

CLAVE	W	V~	FP	Hz	TEMP. DE COLOR	lm	lm/W	VERSIÓN	IRC	PANTALLA	PESO	IP
L5421-510	75	100-305	>0.9	50/60	4000K	8750	117	FIJO	≥82	Transparente	3,645 gr	IP 65
L5421-530					6000K	9000	120					

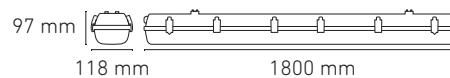
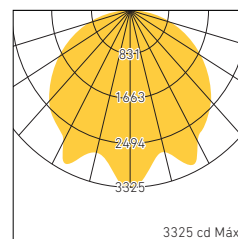

GAMMA LED 1800 H0 LARGA

CLAVE	W	V~	FP	Hz	TEMP. DE COLOR	lm	lm/W	VERSIÓN	IRC	PANTALLA	PESO	IP
L5423-510	100	100-305	>0.9	50/60	4000K	12200	122	FIJO	≥82	Transparente	3,645 gr	IP 65
L5423-530					6000K							

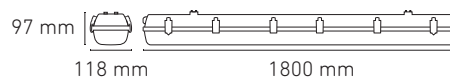
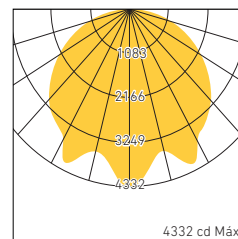

GAMMA TOT

CLAVE	TAMAÑO	W	V~	FP	Hz	TEMP. DE COLOR	lm	lm/W	IRC	PANTALLA	PESO	IP
L5442-510	600 mm	15	90-240	>0.9	50/60	4000K	1530	102	≥82	Opalina	550 gr	IP 65
L5442-530						6000K						
L6801-510	1200 mm	30				4000K	3060	Opalina		955 gr		
L6801-530						6000K						
L6812-510						4000K	3600	Transparente				
L6812-530						6000K						
L5463-510	1500 mm	38	4000K	3800	100	Opalina	3,645 gr					
L5463-530			6000K									

*OPCIONAL: GAMMA TOT 1200 con pantalla transparente.



GAMMA TOT 600

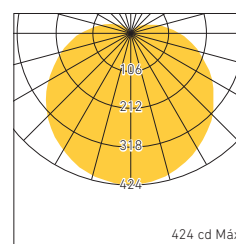
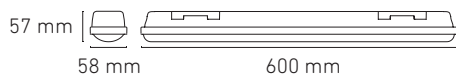

GAMMA TOT 1200

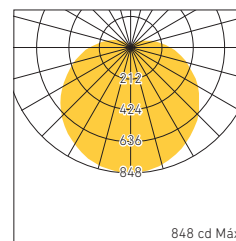
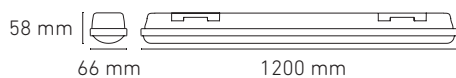

GAMMA TOT 1500

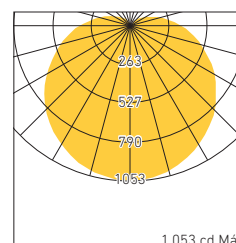
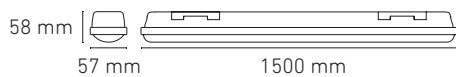

GAMMA LED 1200 S / M (AUTOATENUABLE)

CLAVE	W	V~	FP	Hz	TEMP. DE COLOR	lm	lm/W	IRC	PANTALLA	PESO	IP
L5406-530	29	100-305	>0.9	50/60	6000K	3750	129	≥82	Transparente	2,200 gr	IP 65
L5418-510	50	100-240			4000K	6100	120		Texturizado	2,400 gr	
L5418-530					6000K						



1200 S



1200 M

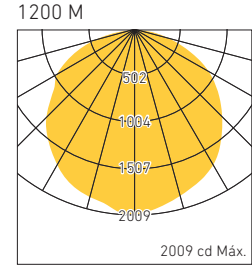
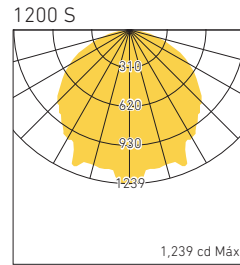

Texturizada

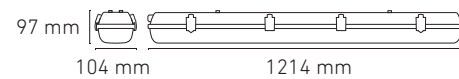

INFORMACIÓN EN SISTEMA AUTOATENUABLE

La Gamma 1200 Autoatenuable integra un sensor de luz natural, el cual manda señales al driver para regular la potencia y flujo luminoso, así compensar y mantener un nivel de luz adecuado en el espacio deseado.



Cuando el sensor registra que existe un nivel mínimo necesario de iluminación proveniente de la luz natural, este, mantiene apagada la luminaria.



Cuando la aportación de luz natural comienza a disminuir, el sensor manda la señal para que la luminaria se encienda y compense para tener el nivel de luz adecuado.



Cuando la aportación de luz natural es mínima, el sensor hace que la luminaria aumente su flujo luminoso para seguir compensando y lograr el nivel de luz adecuado.



Cuando hay nula aportación de luz natural, el sensor hace que la luminaria se encienda al 100%.

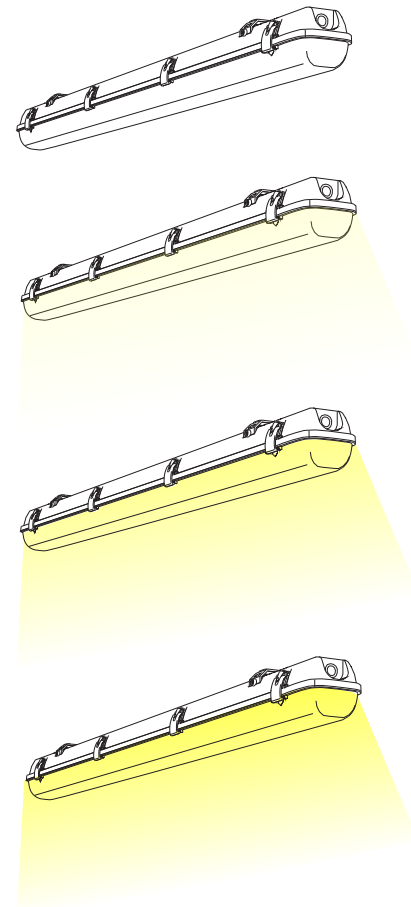

Categoría: INDUSTRIAL COMERCIAL
 Familia: GAMMA CON SISTEMA DE EMERGENCIA

GAMMA LED 600 CON SISTEMA DE EMERGENCIA

CLAVE	W	V~	FP	Hz	TEMP. DE COLOR	lm	lm/W	IRC	PANTALLA	PESO	IP
L5446-510	15	100-240	0.5	50/60	4000K	1670	111	≥82	Texturizado	1,880 gr	IP 65
L5446-530					6000K						

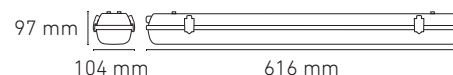
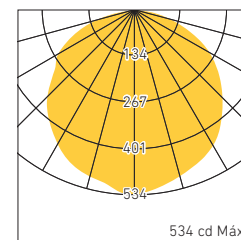

GAMMA LED 1200 S CON SISTEMA DE EMERGENCIA

CLAVE	W	V~	FP	Hz	TEMP. DE COLOR	lm	lm/W	IRC	PANTALLA	PESO	IP
L5457-510	29	100-305	>0.9	50/60	4000K	3660	126	≥82	Texturizado	2,400 gr	IP 65
L5457-530					6000K						

*Este producto es sobre pedido.

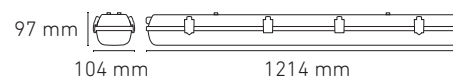
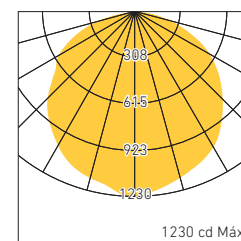

INFORMACIÓN EN MODO DE EMERGENCIA

La serie Gamma con Sistema de Emergencia, integra un driver con baterías de litio recargables que alimentan al driver convencional de la luminaria mientras no hay suministro de energía de la línea. Al regresar el suministro de energía de la línea, el driver carga nuevamente las baterías y queda en estado latente.

- Tiempo de respuesta: Inmediato
- Duración: 120 minutos
- Potencia: 4.5W
- Flujo: 500 lm

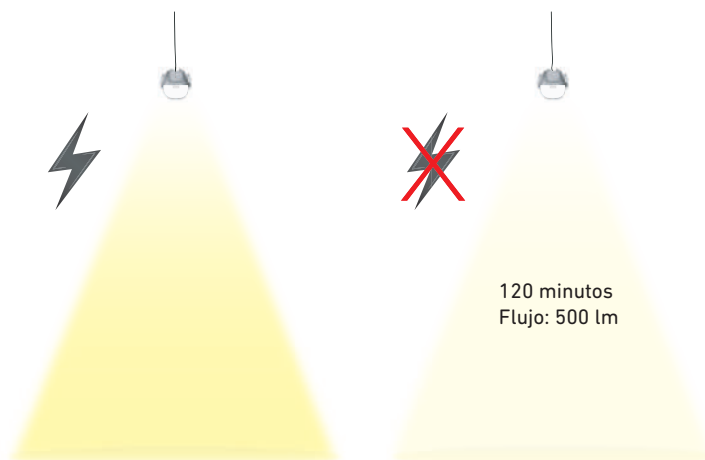

Categoría: INDUSTRIAL COMERCIAL
 Familia: GAMMA CON SENSOR DE MOVIMIENTO

GAMMA LED 600

CLAVE	W	V~	FP	Hz	TEMP. DE COLOR	lm	lm/W	IRC	PANTALLA	PESO	IP
L6840-510	15	100-240	0.5	50/60	4000K	1670	111	≥82	Texturizado	1,880 gr	IP 65
L6840-530					6000K						

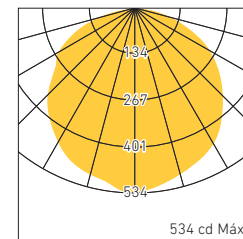
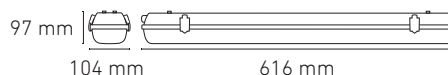

GAMMA LED 1200 S

CLAVE	W	V~	FP	Hz	TEMP. DE COLOR	lm	lm/W	VERSIÓN	IRC	PANTALLA	PESO	IP
L6838-510	29	100-305	>0.9	50/60	4000K	3750	123	FIJO	≥82	Transparente	2,400 gr	IP 65
L6838-530					6000K		124					

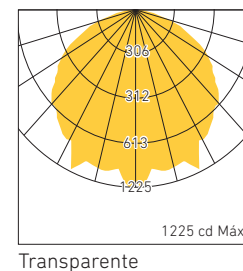
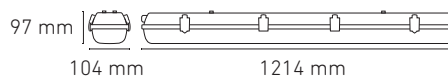

GAMMA LED 1200 M CORTA

CLAVE	W	V~	FP	Hz	TEMP. DE COLOR	lm	lm/W	VERSIÓN	IRC	PANTALLA	PESO	IP
L6839-510	50	100-305	>0.9	50/60	4000K	6000	120	FIJO	≥82	Transparente	2,400 gr	IP 65
L6839-530					6000K							

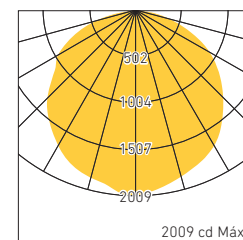
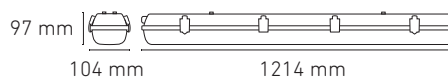

SENSOR DE PRESENCIA TIEMPO DE ACTIVACIÓN 5 MINUTOS

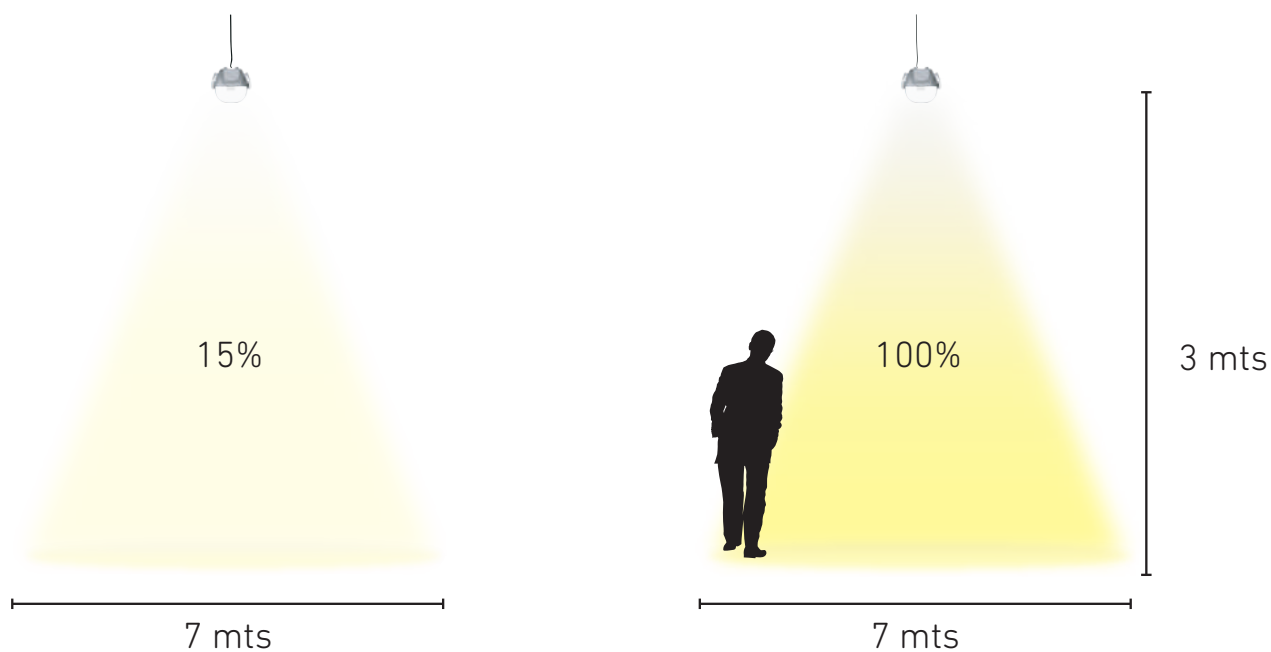

INFORMACIÓN EN SENSOR DE PRESENCIA

La serie Gamma con Sensor de Presencia, integra un sensor que detecta la presencia de usuarios en un rango de 7m de diámetro montada a 3m de altura, el cual manda una señal al driver para que encienda la luminaria al 100%.

Mientras no detecte movimiento durante 5 minutos, la luminaria permanece encendida al 15% ahorrando energía.



60°



CAMPANAS

LED

La familia de Campanas LED de Magg se caracteriza por buscar la estética, funcionalidad y eficiencia contando con la mejor tecnología, confiable y libre de mantenimiento. Son cualidades que en el ámbito industrial y comercial son muy valoradas. La campana prismática de acrílico de alta pureza es un elemento fundamental que define a ésta familia. Además de proporcionar la luz directa y con cierta porción indirecta hacia el techo, reduciendo el contraste y favoreciendo la uniformidad de los espacios comerciales e industriales, se vuelven un elemento decorativo por sus proporciones discretas y bien balanceadas.

Categoría: INDUSTRIAL COMERCIAL

Familia: CAMPANAS LED

CAMPANA 12/20

CLAVE	W	V-	FP	Hz	TEMP. DE COLOR	lm	lm/W	IRC	COLOR	PESO	IP
L5810-6E0	21	100-240	0.5	50/60	3000K	1900	90	≥82	■	2,040 gr	IP 60
L5810-6I0					4000K	2000	95				
L5810-630					6000K						

*Altura máxima 2000 mm.

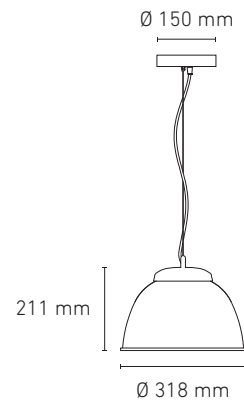
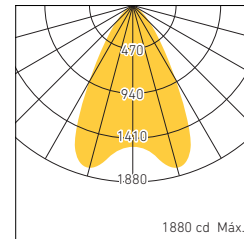

CAMPANA 14/30

CLAVE	W	V-	FP	Hz	TEMP. DE COLOR	lm	lm/W	IRC	COLOR	PESO	IP
L5815-6E0	31	100-240	>0.95	50/60	3000K	2900	94	≥82	■	2,040 gr	60
L5815-6I0					4000K	3030	98				
L5815-630					6000K						

*Altura máxima 2000 mm.

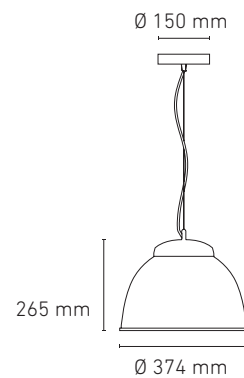
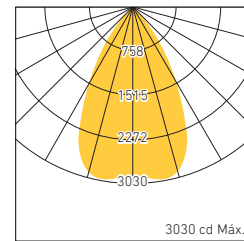

CAMPANA 14/50

CLAVE	W	V~	FP	Hz	TEMP. DE COLOR	lm	lm/W	IRC	COLOR	PESO	IP
L5806-6E0	52	100-305	>0.9	50/60	3000K	4600	88	≥82	■	3,000 gr	IP 60
L5806-6I0					4000K	4850	93				
L5806-630					6000K						

*Altura máxima 1500 mm

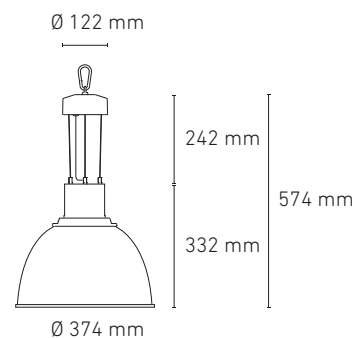
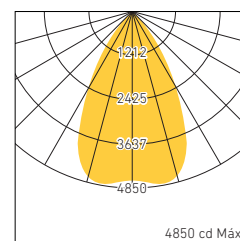

CAMPANA 14/80

CLAVE	W	V~	FP	Hz	TEMP. DE COLOR	lm	lm/W	IRC	COLOR	PESO	IP
L5817-6E0	80	100-305	>0.9	50/60	3000K	7440	93	≥82	■	4,000 gr	IP 60
L5817-6I0					4000K	7770	97				
L5817-630					6000K						

*Altura máxima 1500 mm.

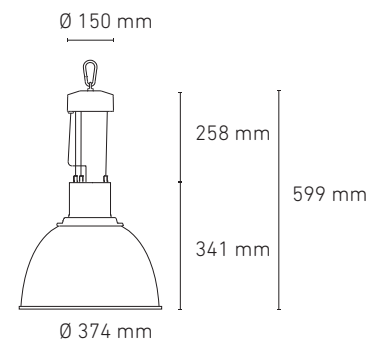
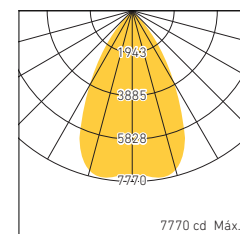



T8



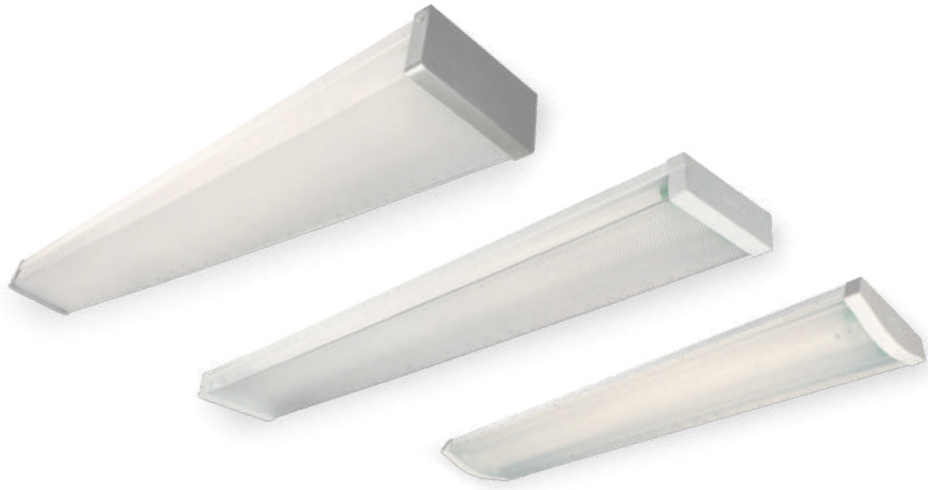

GABINETES METÁLICOS

Volver la vista al pasado nunca es malo, algunos espacios no se entienden sin los elementos tradicionales, es el caso de la línea de gabinetes metálicos de Magg, los cuales conservan una morfología conocida, sin embargo alojan en su interior tecnología LED.

La evolución consiste en cambiar las lámparas fluorescentes por lámparas T8 LED. Es un claro ejemplo de estética vintage respaldado con tecnología de vanguardia. Un concepto nuevo, evolución sin cambio.

TRACK LED

CLAVE	W	V~	FP	Hz	TEMP. DE COLOR	lm	lm/W	IRC	PANTALLA	PESO	IP
L5333-110	2X16	100-240	0.5	50/60	4000K	3400	106	≥82	TEXTURIZADO	2,625 gr	IP 50
L5333-130					6000K						

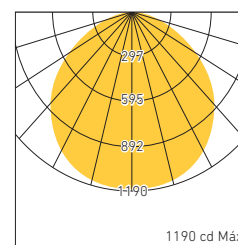
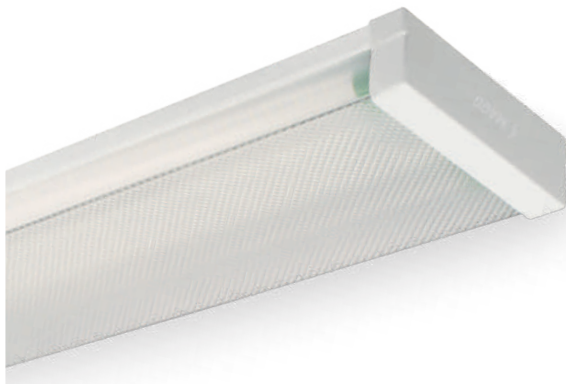

TRACK WAVE LED

CLAVE	W	V~	FP	Hz	TEMP. DE COLOR	lm	lm/W	IRC	PANTALLA	PESO	IP
L5343-110	2X16	100-240	0.5	50/60	4000K	3100	97	≥82	TEXTURIZADO	2,500 gr	IP 50
L5343-130					6000K						

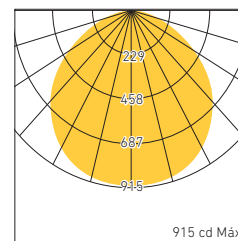
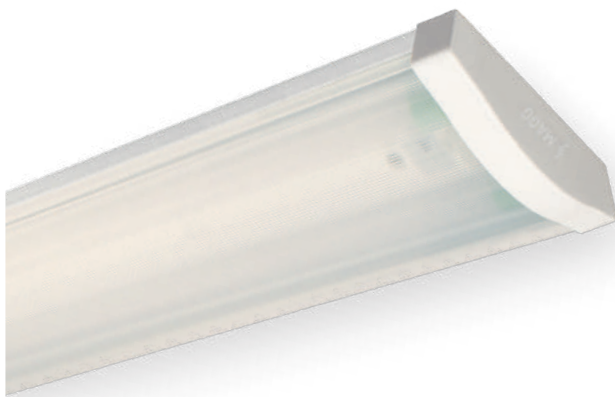

MINI TRACK T8 LED

CLAVE	W	V-	FP	Hz	TEMP. DE COLOR	lm	lm/W	IRC	PANTALLA	PESO	IP
L5335-610	2X16	100-240	0.5	50/60	4000K	3090	100	≥82	TEXTURIZADO	2,502 gr	IP 50
L5335-630					6000K	3180	103				

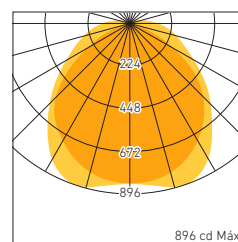
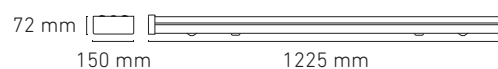
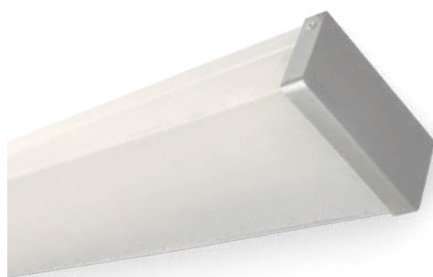

GÉMINIS MINI T8 LED

CLAVE	W	V-	FP	Hz	TEMP. DE COLOR	lm	lm/W	IRC	PESO	IP
L6420-2E0	2X16	100-240	0.5	50/60	3000K	3210	100	≥82	2,300 gr	IP 10
L6420-2I0					4000K	3370	105			
L6420-230					6000K	3500	109			

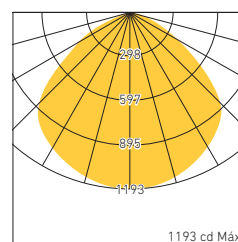



105° / 90 / 50°





HIGHBAY

Si se piensa en grande, entonces la familia de HighBay es la opción. Luminaria con un diseño compacto, el cuerpo está diseñado para disipar el calor generado por la electrónica y los LEDs dando como resultado una familia de luminarias super eficientes, libres de mantenimiento a un costo excepcional. El arreglo de LEDs y su cubierta extra clara logran su máxima apertura para poder cubrir grandes superficies.

Si se quiere dirigir el flujo luminoso a una zona en específico podrían utilizar cualquiera de los dos reflectores de haz limitado que tiene como accesorio.

Categoría: INDUSTRIAL COMERCIAL

Familia: HIGHBAY

HIGHBAY 100W

CLAVE	MODELO	W	V~	FP	Hz	TEMP. DE COLOR	lm	lm/W	IRC	PANTALLA	PESO	IP
L5885-330	BÁSICO	100	100-305	>0.9	50/60	6000K	10300	103	>82	Transparente	1,655 gr	IP 60
L5841-330	STD						12800	128	>82			
L5886-330	PREMIUM						12800	128	>90			

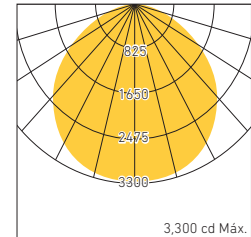
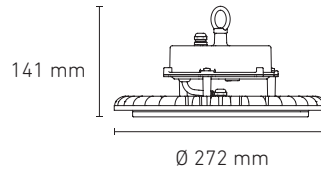

HIGHBAY 150W

CLAVE	MODELO	W	V~	FP	Hz	TEMP. DE COLOR	lm	lm/W	IRC	PANTALLA	PESO	IP
L5888-330	BÁSICO	150	100-305	>0.9	50/60	6000K	15450	103	>82	Transparente	2,146 gr	IP 60
L5842-330	STD						19200	128	>82			
L5889-330	PREMIUM						19200	128	>90			

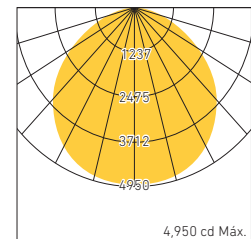
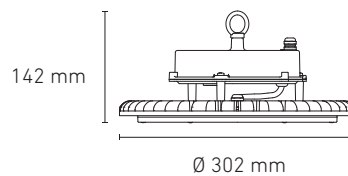

HIGHBAY 200W

CLAVE	MODELO	W	V~	FP	Hz	TEMP. DE COLOR	lm	lm/W	IRC	PANTALLA	PESO	IP
L5891-330	BÁSICO	200	100-305	>0.9	50/60	6000K	20600	103	>82	Transparente	3,667 gr	IP 60
L5874-330	STD						26000	130	>82			
L5892-330	PREMIUM						26000	130	>90			

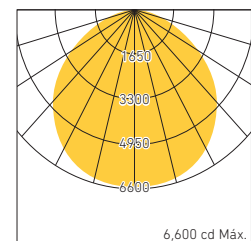
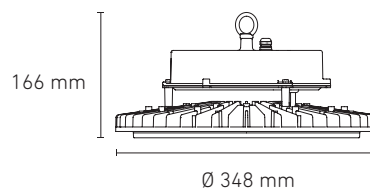

HIGHBAY 300W

CLAVE	MODELO	W	V~	FP	Hz	TEMP. DE COLOR	lm	lm/W	IRC	PANTALLA	PESO	IP
L5875-330	STD	300	100-305	>0.9	50/60	6000K	39000	130	>82	Transparente	5,150 gr	IP 60

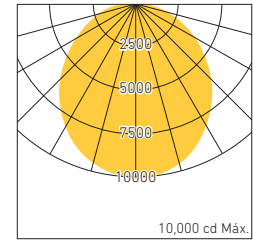
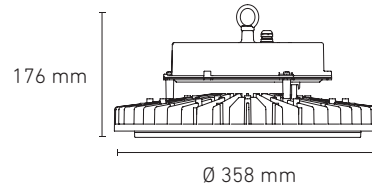

REFLECTOR

(Se vende por separado)

REFLECTOR 50°	CLAVE
REFLECTOR HIGHBAY 50° 100 W	P0014-000
REFLECTOR HIGHBAY 50° 150 W	P0018-000
REFLECTOR HIGHBAY 50° 200 W	P0019-000

REFLECTOR 90°	CLAVE
REFLECTOR HIGHBAY 90° 100 W	P0017-000
REFLECTOR HIGHBAY 90° 150 W	P0023-000
REFLECTOR HIGHBAY 90° 200 W	P0021-000

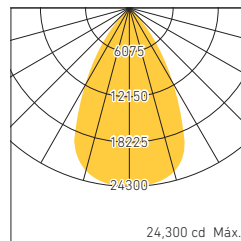

Referencia 200 W

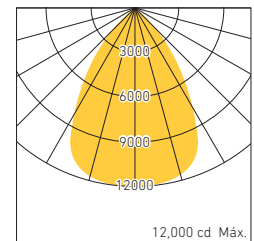

Referencia 200 W

USO GENERAL

SERIE

PÁGINA

SOBREPONER/
SUSPENDER
SERIE II

POTENCIA MEDIA



BL FLAT 300



BL FLAT 450



BL FLAT 600



BL FLAT 900



BL FLAT 1200



BL FLAT 1800

SERIE III

POTENCIA ALTA



BL FLAT 600



BL FLAT 900



BL FLAT 1200



BL FLAT 1800



BL FLAT 2400 128-139

SERIE III

BL FLAT POTENCIA
ALTA INDIRECTO



BL FLAT 900



BL FLAT 1200



BL FLAT 1800

..... 140-141

SERIE BL STICK

SOBREPONER/
SUSPENDER



BL STICK 300



BL STICK 600



BL STICK 900



BL STICK 1200



BL STICK 1800



BL STICK 2400



BL STICK 300
APAGADOR



BL STICK 600
APAGADOR



BL STICK 900
APAGADOR

..... 144-145

SWAN

SOBREPONER



SWAN I



SWAN II



SWAN III



SWAN IV

..... 148-149

CL / CL SQ

SOBREPONER



CL 200



CL 300



CL 400



CL SQ 200



CL SQ 300



CL SQ 400

..... 152-153

INTERIOR / EXTERIOR

PÁGINA

CEILING

SOBREPONER



CEILING 100 CEILING 125 CEILING 200 CEILING 250 156-157

APLIQUES



CEILING 125 PRISMA CEILING 125 REJILLA CEILING 250 REJILLA CEILING 250 PRISMA 158-159

SERIE SW



SW 10 SW 20 SW 30 SW 40 SW 50 SW 60 162-163

SERIE SW AL



SW 10 AL SW 20 AL SW 30 AL SW 40 AL 164-165

SERIE CUBO

SOBREPONER



A8 A10 A12 A15 168

SERIE W II

SOBREPONER



80/80 100/100 120/120 150/150 169

LÁMPARAS

AR111



AR111 172

LÁMPARAS LINEALES



T5 LED T8 LED BÁSICO T8 LED STD T8 LED PLUS T8 LED 2400 FA8 T8 LED 2400 G13 BI PIN 173-174



Por fase



45°



SERIE BL FLAT

La elegancia se expresa siempre con la mínima intensidad, sencillez, trazos limpios, continuos, líneas que recorren los espacios y tienen la capacidad de cambiar el sentido sin perder la continuidad, la habilidad de generar formas geoméricamente puras y poder con ello iluminar los espacios con una variedad de intensidades, temperaturas de color y accesorios de instalación que potencializan su uso, es lo que nos ofrece la familia de la serie BL Flat, estos trazos se pueden hacer con luz directa o indirecta en colores blanco o negro.

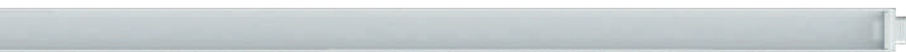

Categoría: **USO GENERAL**
 Familia: **SERIE BL FLAT DIRECTA**



BL Flat es un sistema continuo de iluminación general, decorativa y de diseño para sobreponer o suspender ya sea fija o dirigible. Es reemplazo ideal de luminarias fluorescentes lineales T8 , T5 y tiras LED.



SERIE II
Potencia Media

300 mm		2W
450 mm		3W
600 mm		4W
900 mm		6W
1200 mm		8W
1800 mm		12W

SERIE III
Potencia Alta

600 mm		12W
900 mm		18W
1200 mm		23W
1800 mm		35W
2400 mm		45W

SERIE II BL FLAT POTENCIA MEDIA

CLAVE	TAMAÑO	W	V~	FP	Hz		TEMP. DE COLOR	lm	lm/W	IRC	Piezas máx. interconexión	PESO	IP
L6443-1E0	300 mm	2	100-140	>0.9	50/60		3000K	140	67	≥82	90	73 gr	IP 50
L6443-1I0							4000K						
L6443-130							6000K						
L6408-1E0	450 mm	3					3000K	200	67		4000K		
L6408-1I0							6000K						
L6408-130							6000K						
L6411-1E0	600 mm	4					3000K	270	67		4000K		
L6411-1I0							6000K						
L6411-130							6000K						
L6427-1E0	900 mm	6					3000K	410	68		4000K		
L6427-1I0							6000K						
L6427-130							6000K						
L6436-1E0	1200 mm	8					3000K	530	66		4000K		
L6436-1I0							6000K						
L6436-130							6000K						
L6438-1E0	1800 mm	12	3000K	800	67	4000K							
L6438-1I0			6000K										
L6438-130			6000K										

*Nota se puede solicitar color negro y pantalla transparente

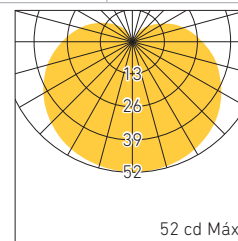
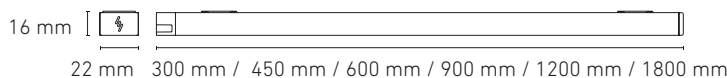

SERIE III BL FLAT POTENCIA ALTA

CLAVE	TAMAÑO	W	V~	FP	Hz		TEMP. DE COLOR	lm	lm/W	IRC	Piezas máx. interconexión	PESO	IP
L6440-1E0	600 mm	12	100-140	>0.9	50/60		3000K	780	65	≥82	15	136 gr	IP 50
L6440-1I0							4000K						
L6440-130							6000K						
L6442-1E0	900 mm	18					3000K	1130	65		4000K		
L6442-1I0							6000K						
L6442-130							6000K						
L6417-1E0	1200 mm	23					3000K	1450	65		4000K		
L6417-1I0							6000K						
L6417-130							6000K						
L6419-1E0	1800 mm	35					3000K	2275	65		4000K		
L6419-1I0							6000K						
L6419-130							6000K						
L6579-1I0	2400 mm	45					4000K	2750	63		4000K		
L6579-130							6000K						

*Nota se puede solicitar color negro y pantalla transparente

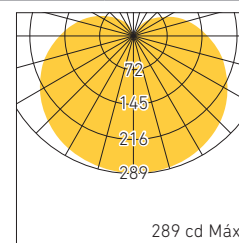
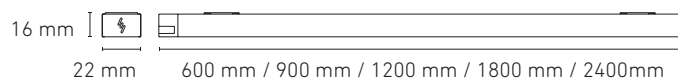

ACCESORIOS DE INTERCONEXIÓN BL FLAT

CONECTORES CON ALIMENTACIÓN

1 CONECTOR DE ALIMENTACIÓN INICIAL
CLAVE: P3767-000

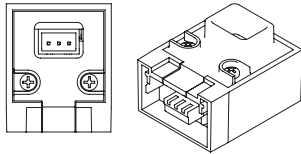

2 CONECTOR 60° ALINEACIÓN VERTICAL TERMINACIÓN CIEGA
CLAVE: P3760-000

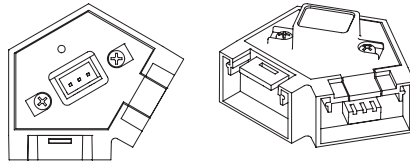

3 CONECTOR 90° ALINEACIÓN VERTICAL TERMINACIÓN CIEGA
CLAVE: P3759-000

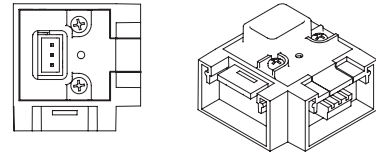

INTERCONEXIÓN

4 INTERCONECTOR LÍNEA CONTINUA
CLAVE: P3704-000

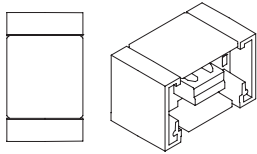

5 CONECTOR 90°
CLAVE: P3712-000

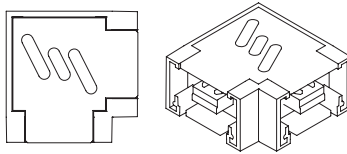

6 CONECTOR "T"
CLAVE: P3768-000

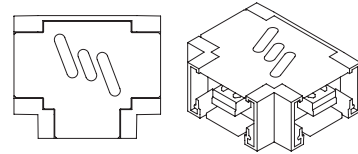

7 CONECTOR 60°
CLAVE: P3766-000

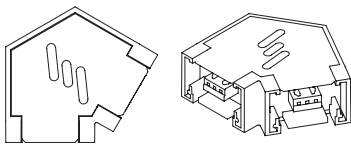

8 CONECTOR 135°
CLAVE: P3758-000

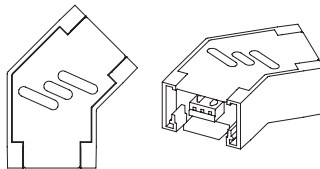

9 CONECTOR 155°
CLAVE: P3777-000

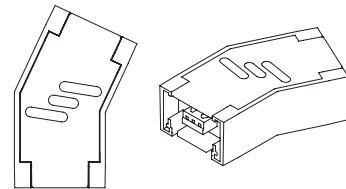

10 CONECTOR 168°
CLAVE: P3785-000

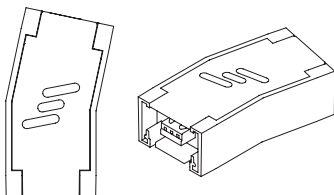

ACCESORIOS COMPATIBLES CON TODA LÍNEA BL FLAT

Toda la línea de accesorios de interconexión, cuenta con kit de suspensión (excepto 1 y 4).

ACCESORIOS PARA MONTAJE

11 KIT PARA SUSPENDER
CLAVE: P3703-000

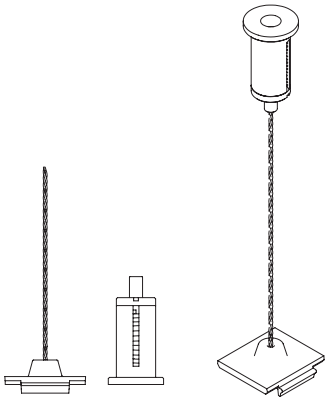

12 BASE FIJA CON IMÁN
CLAVE: P3736-000

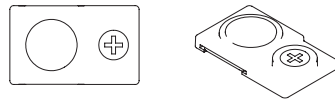

13 BASE MÓVIL CON IMÁN
CLAVE: P3737-000

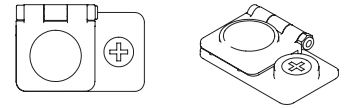

14 CLIP CON IMÁN
CLAVE: P3738-000

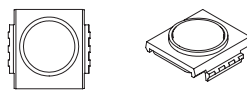

15 CLIP MÓVIL CON IMÁN
CLAVE: P3710-000

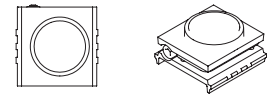

CABLES DE ALIMENTACIÓN

16 CABLE DE ALIMENTACIÓN LATERAL
CLAVE: P3706-000

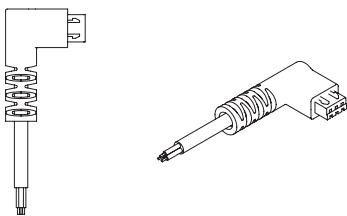

17 CABLE DE ALIMENTACIÓN VERTICAL (2000 mm)
CLAVE: P3707-000

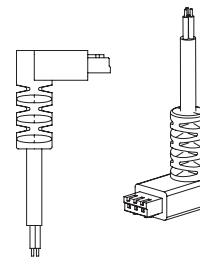

18 CABLE CONECTOR HORIZONTAL DOBLE
CLAVE: P0320-100

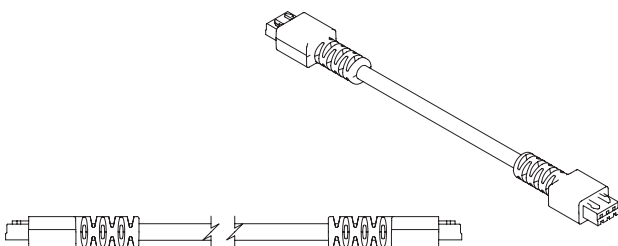

19 CABLE DE ALIMENTACIÓN HORIZONTAL (200 mm)
CLAVE: P3705-000

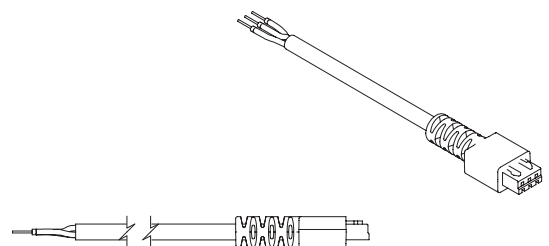



4. INTERCONECTOR LÍNEA CONTINUA

CLAVE: P3704-000

Accesorio de conexión eléctrica-mecánica, permite unir dos módulos de BL FLAT de manera continua, invisible una vez instalado.

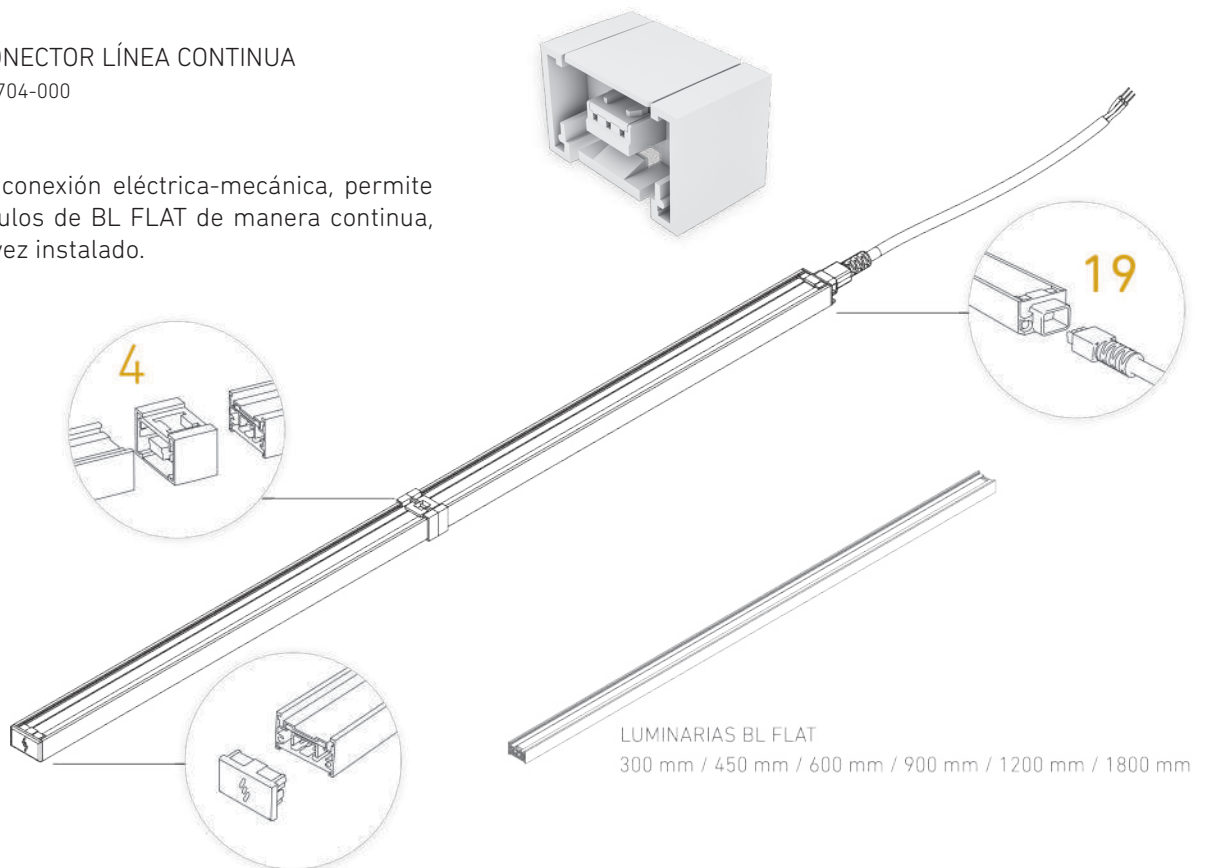

* Tapa inicial incluida en toda la línea BL Flat.



1. CONECTOR ALIMENTACIÓN INICIAL
CLAVE: P3767-000



Accesorio para energizar verticalmente un módulo de BL FLAT (Suspensión vertical).

CONECTOR 90°
CLAVE: P3712-000

5. Accesorio para unir y alimentar dos módulos BL FLAT de manera perpendicular.

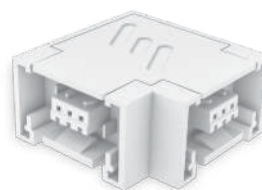

LUMINARIAS BL FLAT
300 mm / 450 mm / 600 mm / 900 mm / 1200 mm / 1800 mm

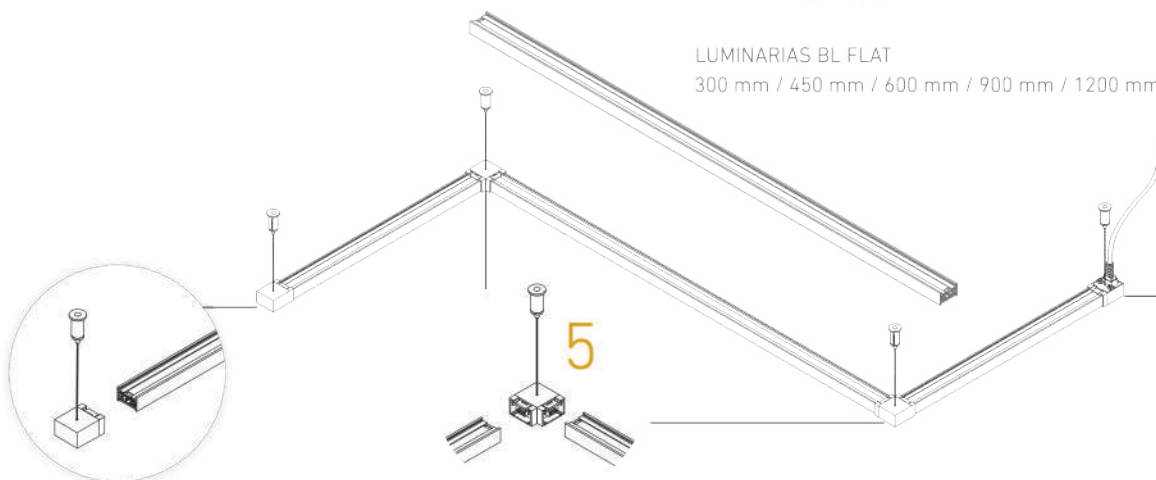

* Tapa inicial incluida en toda la línea BL Flat.



3. CONECTOR 90° ALIMENTACIÓN
VERTICAL TAPA CIEGA
CLAVE: P3759-000

Accesorio para unir y alimentar dos módulos BL FLAT de manera perpendicular, cuenta con entrada de alimentación en la parte superior.



5. CONECTOR 90°
CLAVE: P3712-000

Accesorio para unir y alimentar dos módulos BL FLAT de manera perpendicular.

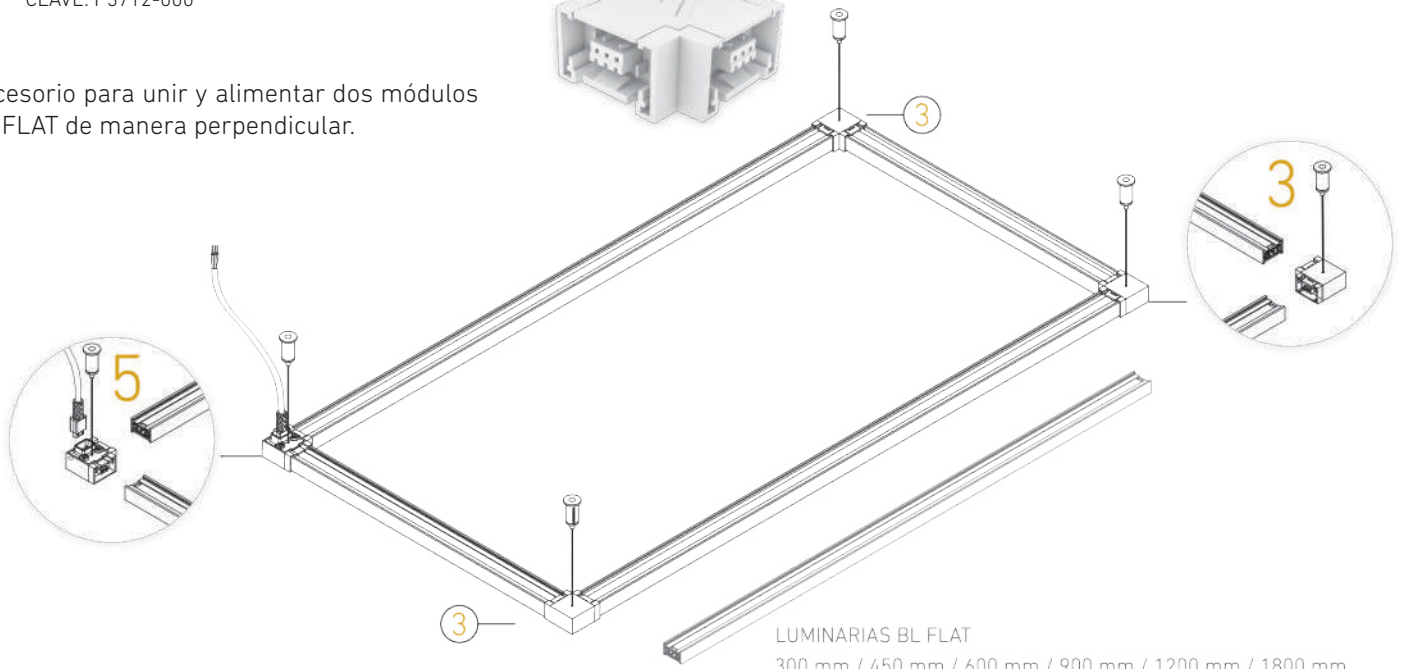
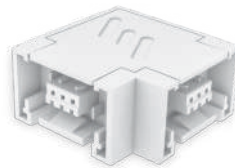



2. CONECTOR 60° ALIMENTACIÓN VERTICAL TAPA CIEGA
CLAVE: P3760-000



Accesorio para unir y alimentar dos módulos BL FLAT formando un ángulo de 60°, cuenta con entrada de alimentación en la parte superior.

7. CONECTOR 60°
CLAVE: P3766-000



Accesorio para unir y alimentar dos módulos BL FLAT formando un ángulo de 60°.

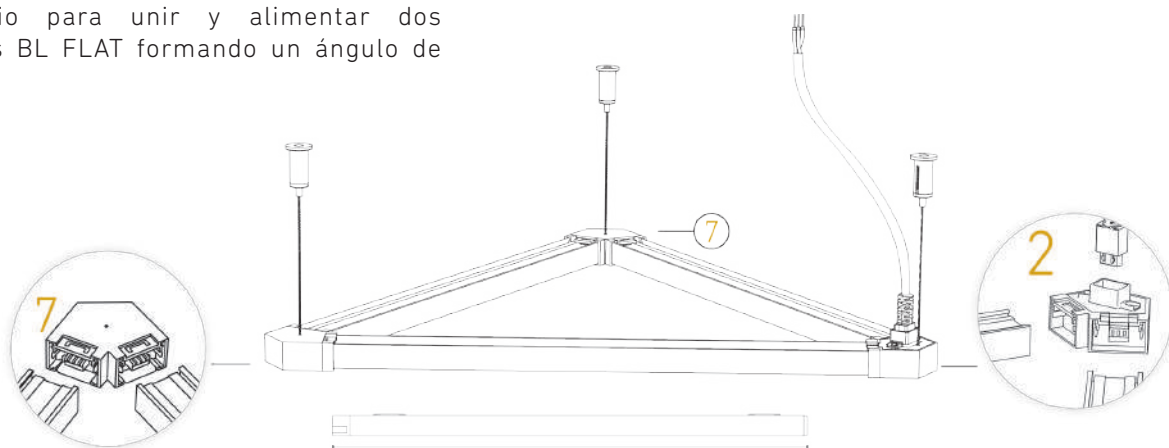

LUMINARIAS BL FLAT
300 mm / 450 mm / 600 mm / 900 mm / 1200 mm / 1800 mm

* Tapa inicial incluida en toda la línea BL Flat.

6. CONECTOR T
CLAVE: P3768-000

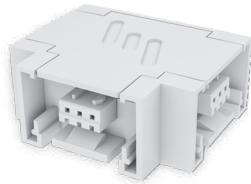

Accesorio de conexión eléctrica-mecánica, permite unir dos módulos de BL FLAT de manera continua, invisible una vez instalado.

8. CONECTOR 135°
CLAVE: P3760-000



Accesorio para unir y alimentar dos módulos BL FLAT formando un ángulo de 60°, cuenta con entrada de alimentación en la parte superior.

9. CONECTOR 155°
CLAVE: P3766-000



Accesorio para unir y alimentar dos módulos BL FLAT formando un ángulo de 60°.

10. CONECTOR 168°
CLAVE: P3766-000



Accesorio para unir y alimentar dos módulos BL FLAT formando un ángulo de 60°.

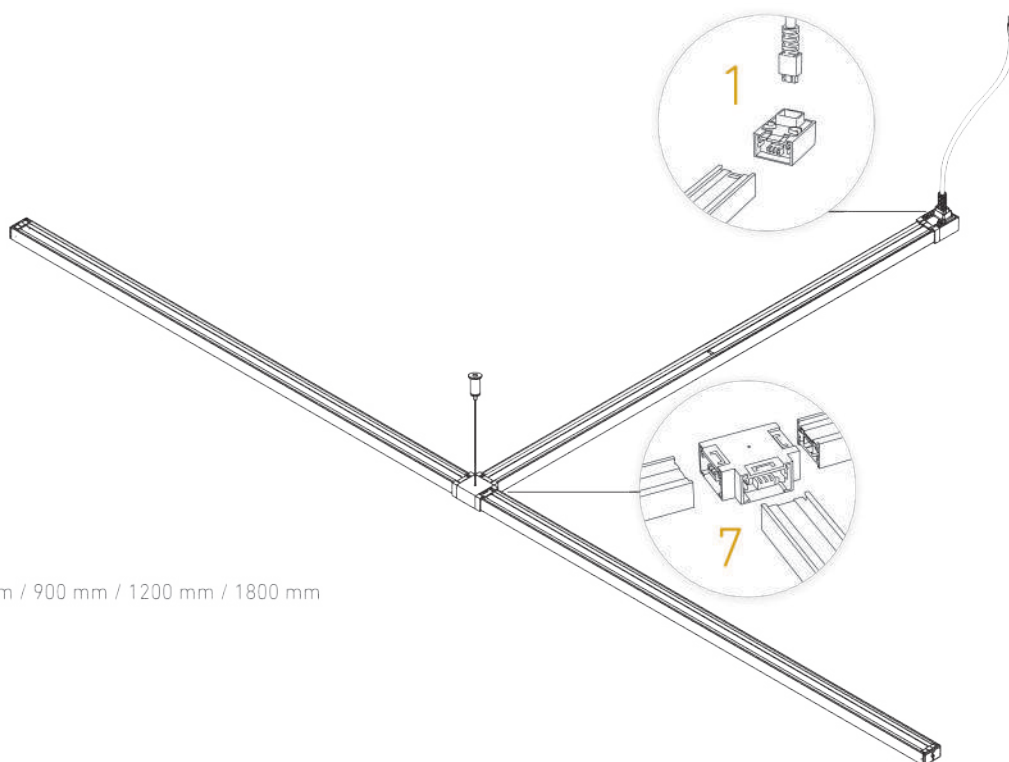

LUMINARIAS BL FLAT
300 mm / 450 mm / 600 mm / 900 mm / 1200 mm / 1800 mm

* Tapa inicial incluida en toda la línea BL Flat.



TABLA DE AMPLITUD PARA ZIGZAG

BL FLAT	H (mm)		
	CONECTOR		
	135°	155°	168°
300	153	99	61
450	211	131	77
600	268	164	92
900	383	228	124
1200	498	293	155
1800	727	423	218



* Tapa inicial incluida en toda la línea BL Flat.

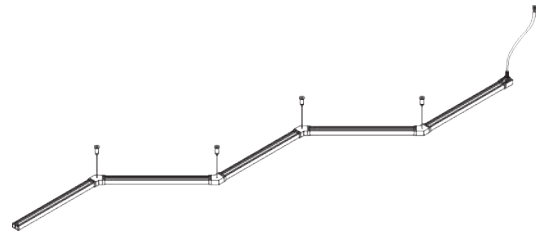
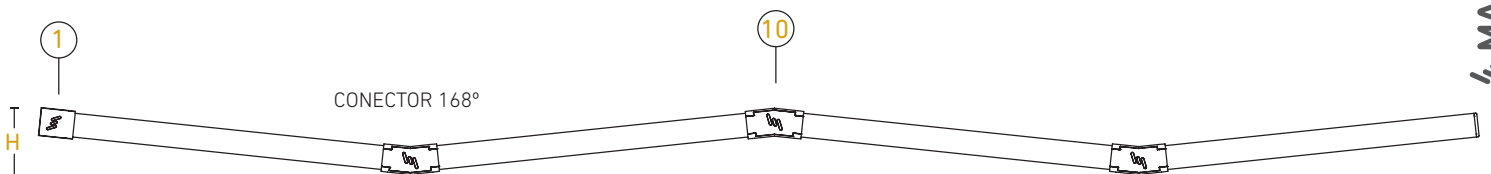
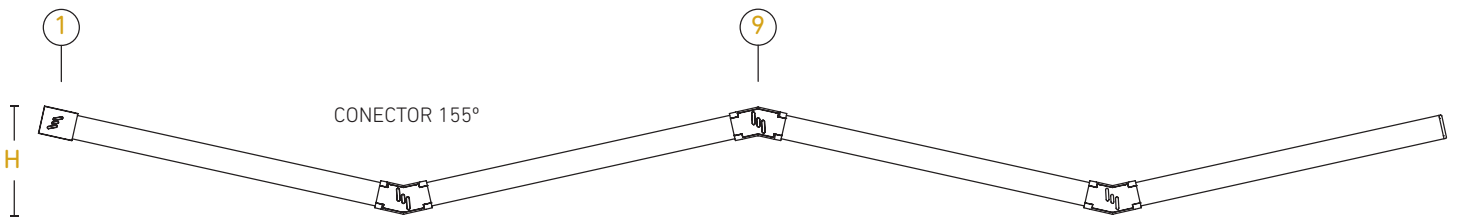
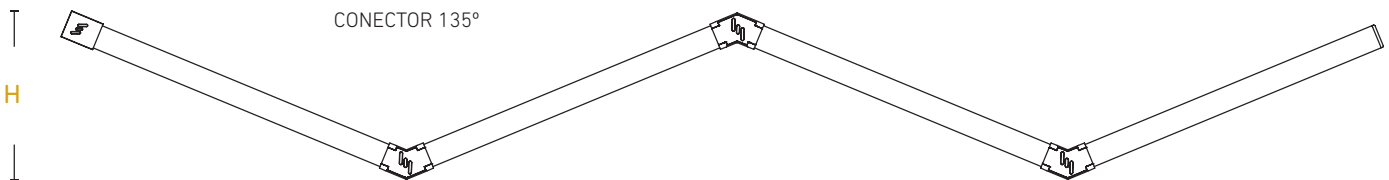
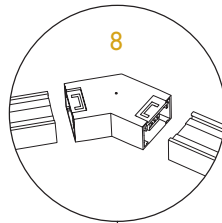
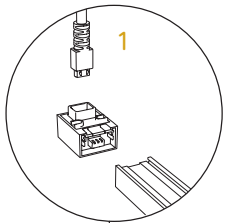

12. BASE FIJA CON IMÁN

CLAVE: P3736-000



La base fija con imán permite colocar las luminarias BL FLAT en superficies lisas o rugosas.

13. BASE MÓVIL CON IMÁN

CLAVE: P3737-000



La base móvil con imán permite colocar las luminarias BL FLAT en superficies lisas o rugosas, permitiendo orientar la luminaria a 45°.

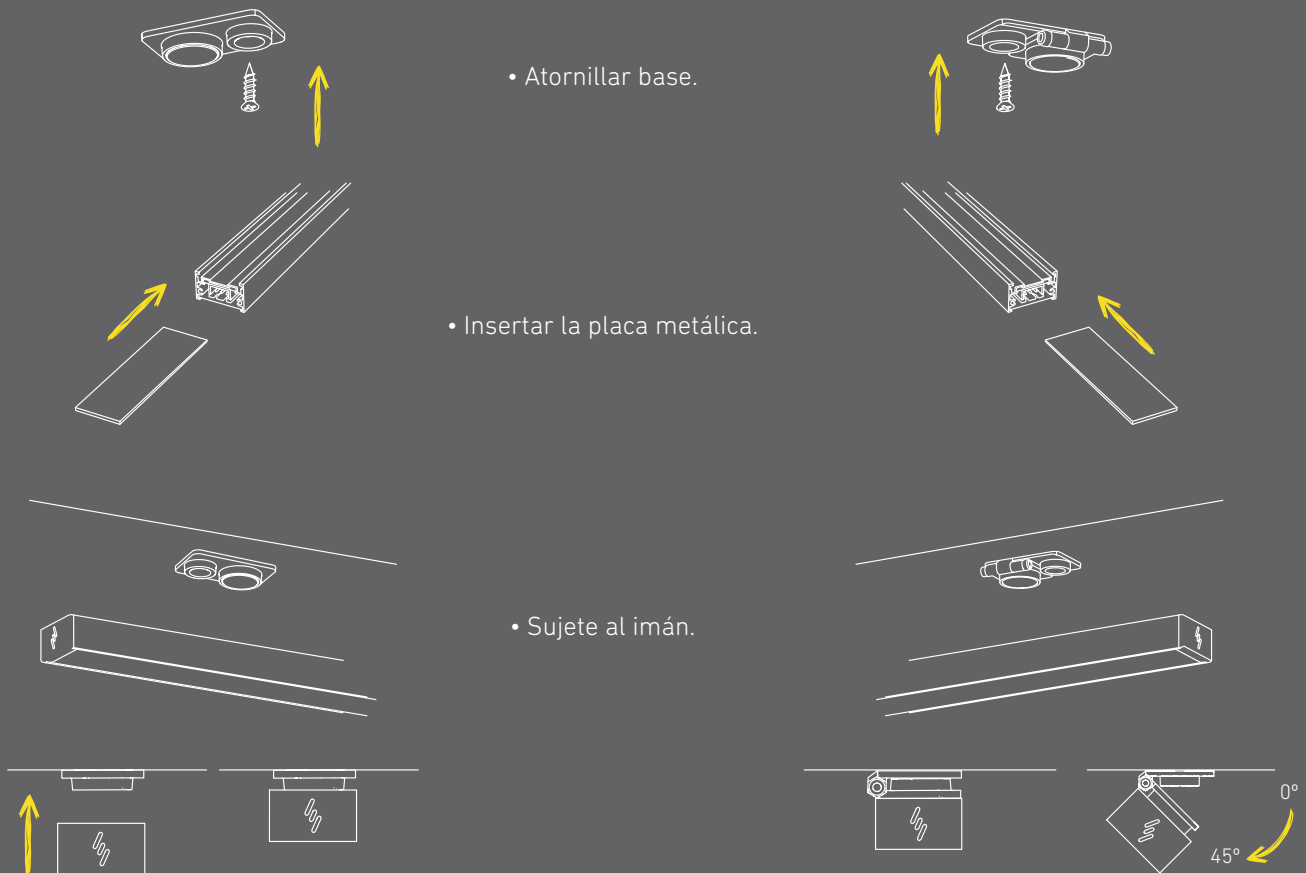

Accesorios ideales para: Cocinas, repisas, gavetas y mobiliario en general.

— CLIP CON IMÁN —

14. CLIP CON IMÁN CLAVE: P3738-000



El clip fijo con imán permite colocar las luminarias BL FLAT en superficies lisas metálicas.

15. CLIP MÓVIL CON IMÁN CLAVE: P3710-000

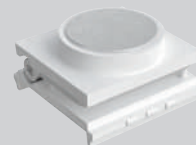

El clip móvil con imán permite colocar las luminarias BL FLAT en superficies lisas metálicas, permitiendo orientar la luminaria a 45°.

• Insertar clip con imán.

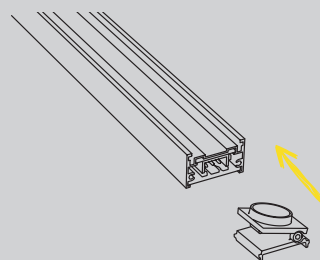
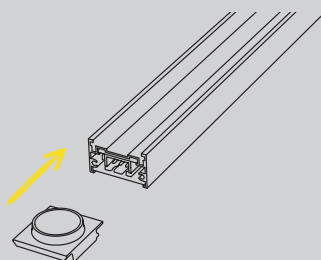

Opción 1. Superficie ferrosa: No se requiere placa metálica.

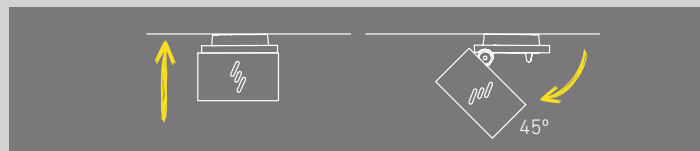
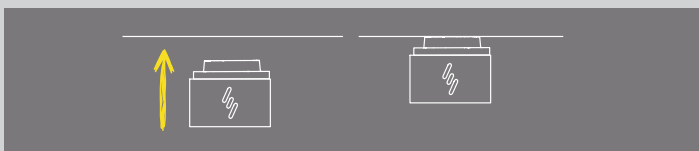

Opción 2. Superficie ferrosa: No se requiere placa metálica.

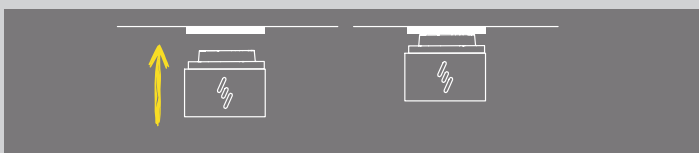

SE COLOCA FÁCIL EN CUALQUIER SUPERFICIE LISA TANTO FERROSA COMO NO FERROSA.



21. INTERCONECTOR LÍNEA CONTINUA
CLAVE: P3818-000

Accesorio de conexión eléctrica-mecánica, permite unir dos módulos de BL FLAT INDIRECTA de manera continua, invisible una vez instalado.

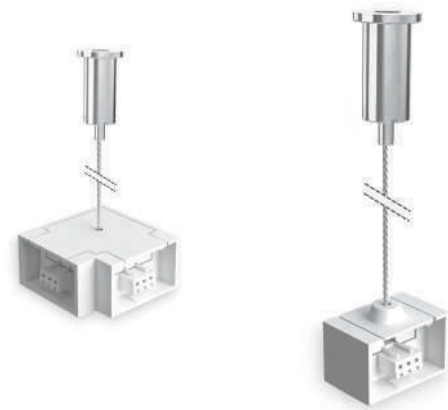
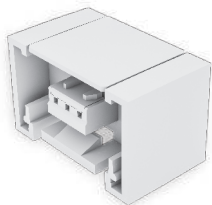

22. CONECTOR 90°
CLAVE: P3817-000

Accesorio para unir y alimentar dos módulos BL FLAT INDIRECTA de manera perpendicular.

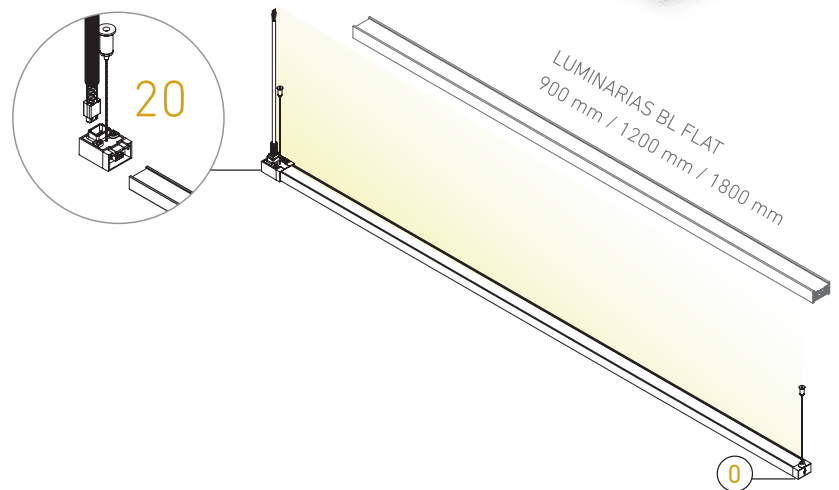

SERIE III

BL FLAT POTENCIA ALTA INDIRECTA

CLAVE	TAMAÑO	W	V-	FP	Hz		TEMP. DE COLOR	lm	lm/W	IRC	Piezas máx. interconexión	PESO	IP
L6514-110	900 mm	18	100-140	>0.9	50/60		4000K	780	65	≥82	15	136 gr	IP 50
L6514-130							6000K				10		
L6515-110	1200 mm	23					4000K	1130	65		10	190 gr	
L6515-130							6000K				8		
L6516-110	1800 mm	35					4000K	1450	65		8	252 gr	
L6516-130							6000K						

*Nota se puede solicitar color negro y pantalla transparente

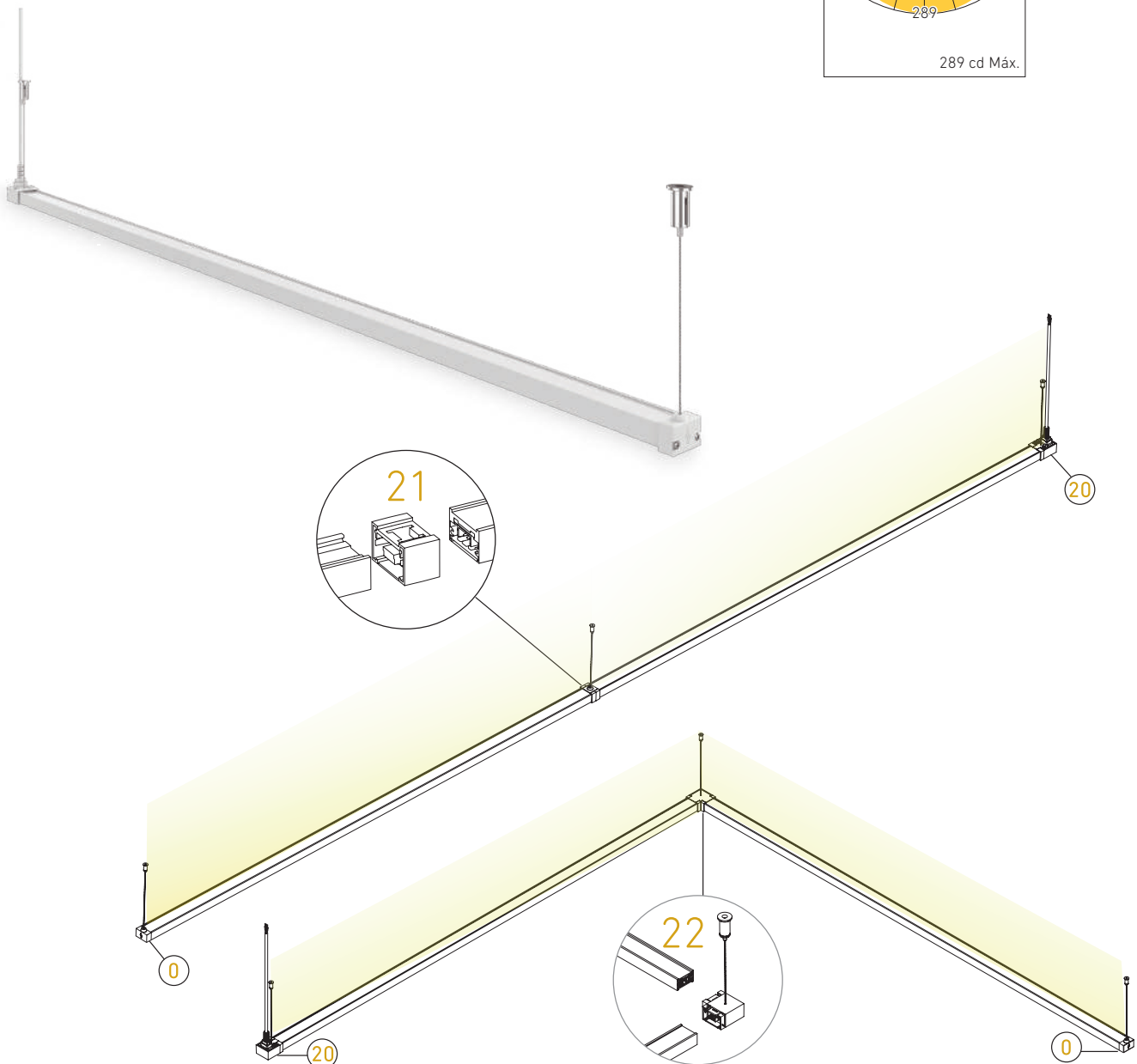
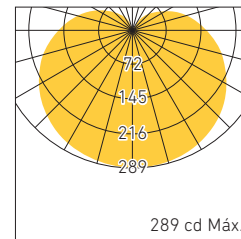



$\pm 45^\circ$



SERIE BL STICK

Líneas continuas de emisión difusa y de alta salida luminosa con un excelente índice de reproducción de color es la característica primordial de la familia BL Stick. Con la fácil manera de instalar estas luminarias y la comodidad de su interconexión se pueden lograr resolver de una manera ágil cualquier circunstancia lumínica. Y en algunos casos la practicidad de contar con un apagador local en cada luminaria, aumenta sus beneficios.

Categoría: USO GENERAL
 Familia: SERIE BL STICK

BL STICK

CLAVE	TAMAÑO	W	V-	FP	Hz	TEMP. DE COLOR	lm	lm/W	IRC	COLOR	PESO	IP
L6502-1E0	300 mm	5	100-240	0.5	50/60	3000K	435	87	≥82	□	120 gr	IP 50
L6502-1I0						4000K	460	92				
L6503-1E0	600 mm	9				3000K	855	95			210 gr	
L6503-1I0						4000K	900	100				
L6504-1E0	900 mm	14				3000K	1330	95			293 gr	
L6504-1I0						4000K	1400	100				
L6504-130						6000K						
L6484-1E0	1200 mm	21				3000K	1995	95			383 gr	
L6484-1I0						4000K	2100	100				
L6484-130						6000K						
L6494-1E0	1800 mm	32				3000K	3040	95			609 gr	
L6494-1I0						4000K	3200	100				
L6494-130			6000K									
L6481-1E0	2400 mm	42	3000K	3990	95	738 gr						
L6481-1I0			4000K	4200	100							
L6481-130			6000K									

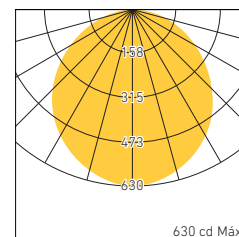
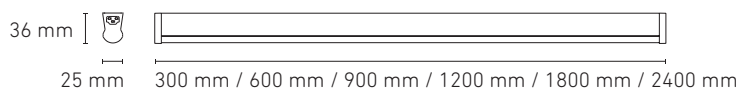
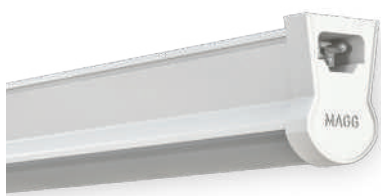

BL STICK APAGADOR

CLAVE	TAMAÑO	W	V-	FP	Hz	TEMP. DE COLOR	lm	lm/W	IRC	COLOR	PESO	IP
L6501-1I0	300 mm	5	100-240	0.5	50/60	4000K	460	92	≥82	□	130 gr	IP 50
L6482-1I0	600 mm	9					900	100			220 gr	
L6483-1I0	900 mm	14					1400				303 gr	

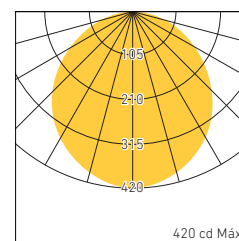
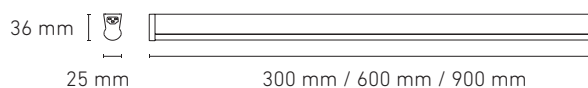

ACCESORIOS BL STICK

Accesorios
CLAVE: P3721-000



Herraje móvil



Conector simple



Tapa para terminal

A Herraje móvil incluido en toda la gama BL STICK

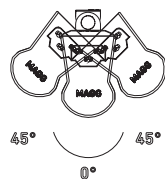
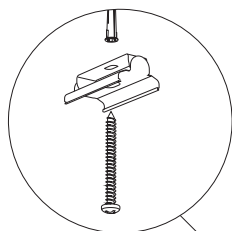

C Cable de alimentación horizontal

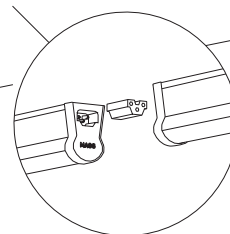
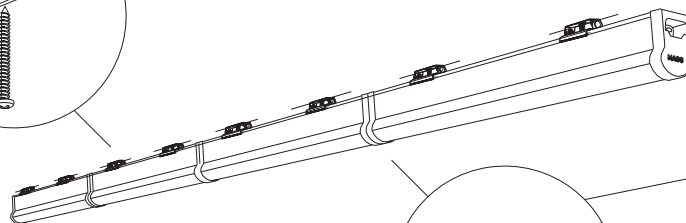
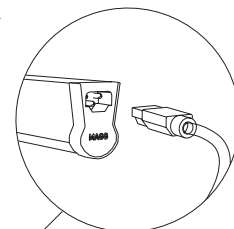

B Conector simple

CONECTOR 90°
CLAVE: P3783-000



Accesorio de conexión eléctrica-mecánica, permite unir dos módulos de BL STICK en un ángulo de 90°.

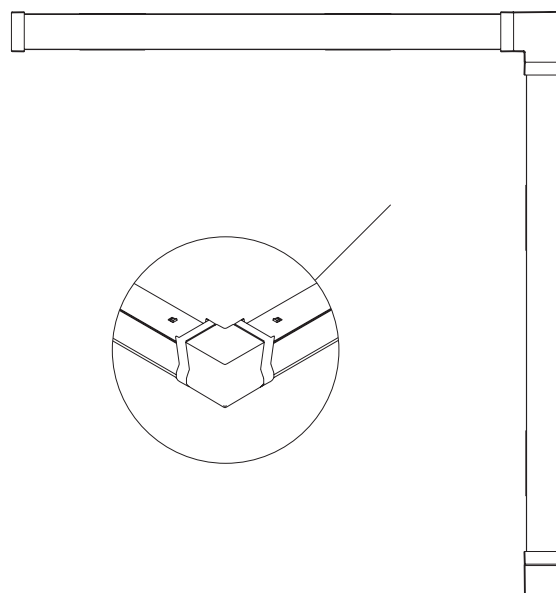

PIEZAS MÁX. INTERCONEXIÓN BL STICK	
300	50
600	28
900	18
1200	12
1800	8
2400	6



Perilla



45°





S E R I E SWAN

En un mundo global la individualidad resulta ser esencial para conservar el sentido de pertenencia, es por eso que, contar con una iluminación local, que pueda acompañarte de forma tan personal, con un sistema de sujeción para cada situación que además puedas dirigir la emisión de luz de manera completamente flexible y controlable de manera individual. Son los lineamientos principales al desarrollar la familia Swan.

Categoría: USO GENERAL

Familia: SERIE SWAN

SWAN I

CLAVE	W	V~	FP	Hz	TEMP. DE COLOR	lm	lm/W	ÁNGULO	IRC	COLOR	PESO	IP
L5150-EI9	1.6	100-240	0.5	50/60	4000K	100	59	45°	≥82	■	260 gr	IP 40
L5150-3I9					4000K	100				□		

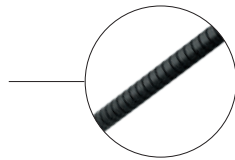

Brazo metalico flexible

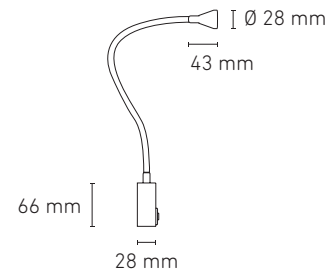
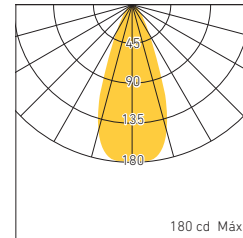

SWAN II

CLAVE	W	V~	FP	Hz	TEMP. DE COLOR	lm	lm/W	ÁNGULO	IRC	COLOR	PESO	IP	
L5151-EI9	1.7	100-140	0.5	50/60	Si	4000K	100	59	45°	≥82	■	235 gr	IP 40
L5151-3I9											□		



Goma de protección contra temperatura.



Atenuable

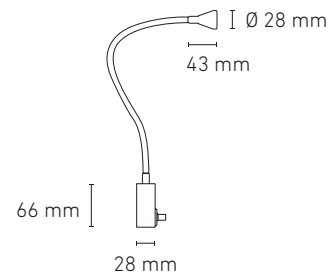

SWAN III

CLAVE	W	V~	FP	Hz		TEMP. DE COLOR	lm	lm/W	ÁNGULO	IRC	COLOR	PESO	IP
L5152-EI9	1.7	100-140	0.5	50/60	Si	4000K	100	59	45°	≥82	■	295 gr	IP 40
L5152-3I9											□		



SWAN IV

CLAVE	W	V~	FP	Hz		TEMP. DE COLOR	lm	lm/W	ÁNGULO	IRC	COLOR	PESO	IP
L5153-EI9	1.7	100-140	0.5	50/60	Si	4000K	100	59	45°	≥82	■	420 gr	IP 40
L5153-3I9											□		







SERIES _____
CL Y CL SQ

En espacios donde no se pueden empotrar las luminarias, se necesita contar con formas básicas, trazos sencillos y de diversos tamaños. Por ser luminarias que se encuentran expuestas todo el tiempo, se imprime especial atención a su diseño para hacerlas durables, los materiales de construcción, la solidez de sus elementos y la temperatura de color para poder solucionar de manera efectiva los requerimientos tanto del diseñador de iluminación como de la instalación.

Categoría: USO GENERAL

Familia: SERIE CL

CL 200

CLAVE	W	V~	FP	Hz	TEMP. DE COLOR	lm	lm/W	IRC	COLOR	PESO	IP
L5213-8E0	12	100-240	0.5	50/60	3000K	1140	95	≥82	■	358 gr	IP 50
L5213-830					6000K	1250	104				
L5213-1E0					3000K	1140	95		□		
L5213-130					6000K	1250	104				

Opcional atenuable

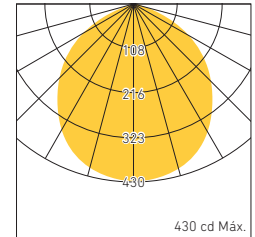
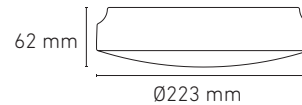

CL 300

CLAVE	W	V~	FP	Hz	TEMP. DE COLOR	lm	lm/W	IRC	COLOR	PESO	IP
L5235-8E0	17	100-240	0.5	50/60	3000K	1600	95	≥82	■	688 gr	IP 50
L5235-830					6000K	1700	100				
L5235-1E0					3000K	1600	95		□		
L5235-130					6000K	1700	100				

Opcional atenuable

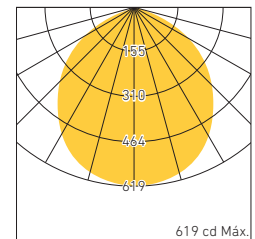
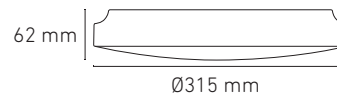

CL 400

CLAVE	W	V~	FP	Hz	TEMP. DE COLOR	lm	lm/W	IRC	COLOR	PESO	IP
L5236-8E0	25	100-240	0.5	50/60	3000K	2370	94	≥82	■	1,818 gr	IP 50
L5236-830					6000K	2400	97				
L5236-1E0					3000K	2370	94		□		
L5236-130					6000K	2400	97				

Opcional atenuable

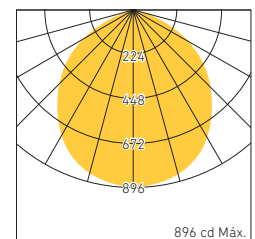
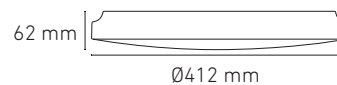

Categoría: USO GENERAL

Familia: SERIE CL SQ

CL SQ 200

CLAVE	W	V~	FP	Hz	TEMP. DE COLOR	lm	lm/W	IRC	COLOR	PESO	IP
L5241-8E0	12	100-240	0.5	50/60	3000K	1140	95	≥82	■	366 gr	IP 50
L5241-830					6000K	1250	104				
L5241-1E0					3000K	1140	95		□		
L5241-130					6000K	1250	104				

Opcional atenuable

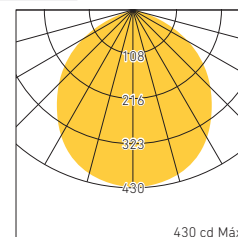
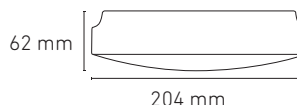

CL SQ 300

CLAVE	W	V~	FP	Hz	TEMP. DE COLOR	lm	lm/W	IRC	COLOR	PESO	IP
L5242-8E0	17	100-240	0.5	50/60	3000K	1600	95	≥82	■	624 gr	IP 50
L5242-830					6000K	1700	100				
L5242-1E0					3000K	1600	95		□		
L5242-130					6000K	1700	100				

Opcional atenuable

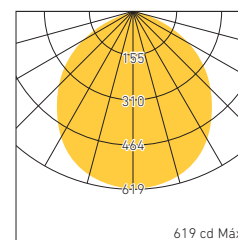
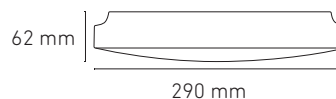

CL SQ 400

CLAVE	W	V~	FP	Hz	TEMP. DE COLOR	lm	lm/W	IRC	COLOR	PESO	IP
L5243-8E0	25	100-240	0.5	50/60	3000K	2370	94	≥82	■	1,442 gr	IP 50
L5243-830					6000K	2400	97				
L5243-1E0					3000K	2370	94		□		
L5243-130					6000K	2400	97				

Opcional atenuable

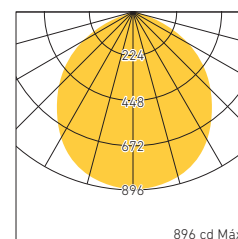
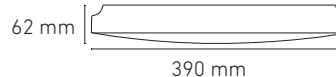



Por fase



50,000 Hrs.





S E R I E CEILING

La diversidad en la aplicación de luminarias para iluminación de exterior con requerimientos de luz general y de cortesía con demandas superiores de sellado, nos ha llevado al desarrollo de productos de formas básicas, trazos sencillos con proporciones discretas en tamaños pequeños y medianos.

La familia Ceiling se destaca por su construcción a base de materiales muy duraderos para un uso incluso extremo, poder contar con luminarias libres de mantenimiento y con la misma apariencia a través del tiempo.

Categoría: USO GENERAL

Familia: SERIE CEILING

CEILING 100

CLAVE	W	V~	FP	Hz	TEMP. DE COLOR	lm	lm/W	IRC	COLOR	PESO	IP
L5201-1E0	5	100-140	0.5	50/60	3000K	350	71	≥90	□	200 gr	65
L5201-130					6000K	370	74				

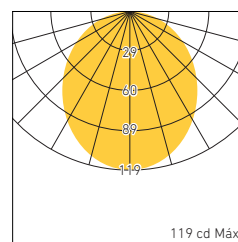
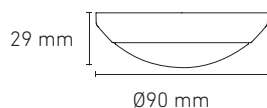

CEILING 125

CLAVE	W	V~	FP	Hz		TEMP. DE COLOR	lm	lm/W	IRC	COLOR	PESO	IP
L5250-1E0	10	100-140	≥0.95	50/60	Por Fase*	3000K	810	81	≥90	□	270gr.	IP 65
L5250-130						6000K	840	84				

SSD SOLID STATE DRIVER

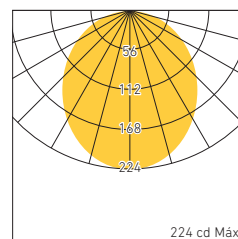
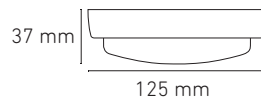

CEILING 200

CLAVE	W	V-	FP	Hz		TEMP. DE COLOR	lm	lm/W	IRC	COLOR	PESO	IP
L5245-1E0	15	100-140	≥0.95	50/60	Por Fase*	3000K	1100	73	≥90	<input type="checkbox"/>	465 gr	IP 65
L5245-8E0						<input type="checkbox"/>						
L5245-130						<input type="checkbox"/>						
L5245-830						<input type="checkbox"/>						

SSD | SOLID STATE DRIVER

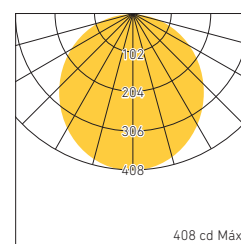
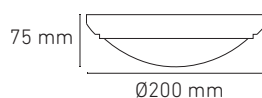

CEILING 250

CLAVE	W	V-	FP	Hz		TEMP. DE COLOR	lm	lm/W	IRC	COLOR	PESO	IP
L5265-1E0	22	100-140	≥0.95	50/60	Por Fase*	3000K	1820	83	≥90	<input type="checkbox"/>	595 gr	IP 65
L5265-8E0						<input type="checkbox"/>						
L5265-130						<input type="checkbox"/>						
L5265-830						<input type="checkbox"/>						

SSD | SOLID STATE DRIVER

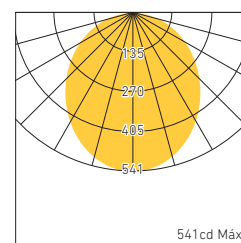
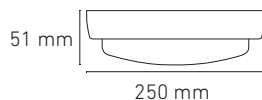

Categoría: MURO

Familia: APLIQUES CEILING

CEILING 125 PRISMA

CLAVE	W	V-	FP	Hz		TEMP. DE COLOR	lm	lm/W	IRC	COLOR	PESO	IP
L5255-1E0	4	100-140	≥0.95	50/60	Por Fase*	3000K	185	46	≥90	□	350 gr	IP 65
L5255-130						6000K	195	49				

SSD SOLID STATE DRIVER

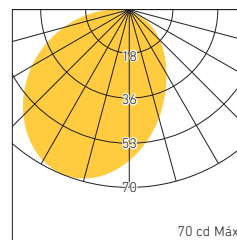
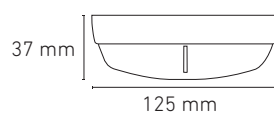

CEILING 125 REJILLA

CLAVE	W	V-	FP	Hz		TEMP. DE COLOR	lm	lm/W	IRC	COLOR	PESO	IP
L5260-1E0	4	100-140	≥0.95	50/60	Por Fase*	3000K	260	65	≥90	□	300 gr	IP 65
L5260-130						6000K	270	67				

SSD SOLID STATE DRIVER

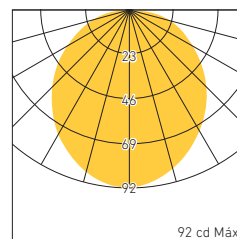
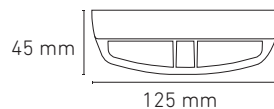

CEILING 250 PRISMA

CLAVE	W	V~	FP	Hz		TEMP. DE COLOR	lm	lm/W	IRC	COLOR	PESO	IP
L5270-1E0	8	100-140	≥0.95	50/60	Por Fase*	3000K	390	49	≥90	□	700 gr	IP 65
L5270-130						6000K	400	50				

SSD | SOLID STATE DRIVER

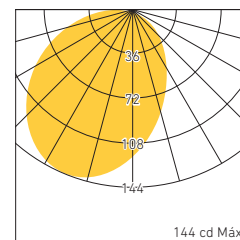
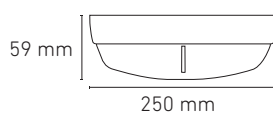

CEILING 250 REJILLA

CLAVE	W	V~	FP	Hz		TEMP. DE COLOR	lm	lm/W	IRC	COLOR	PESO	IP
L5275-1E0	8	100-140	≥0.95	50/60	Por Fase*	3000K	670	84	≥90	□	630 gr	IP 65
L5275-130						6000K	680	85				

SSD | SOLID STATE DRIVER

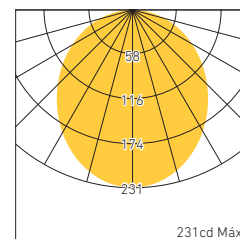
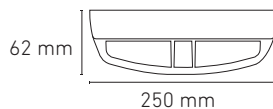



Por fase



50,000 Hrs.



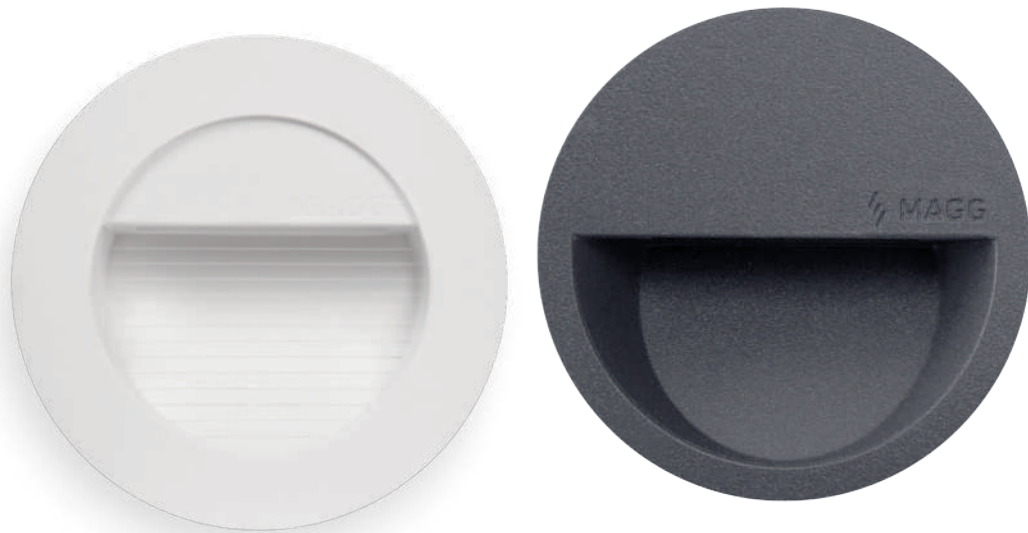

S E R I E SW Y SW AL

Para aplicaciones en áreas exteriores la seguridad es un punto muy importante para nosotros, además de poder brindarlo le damos un toque de diseño, entonces los resultados son completamente satisfactorios.

La familia de luminarias SW y SW AL. cuentan con versiones para empotrar y para sobreponer en los muros. Siempre buscando tener productos de alta resistencia a los climas extremos, durabilidad para mantener la apariencia con el paso del tiempo.

Diseños sencillos y fácilmente combinables con tecnología LED de super ahorro.

Categoría: MURO
 Familia: SERIE SW

SW 10

CLAVE	W	V-	FP	Hz	TEMP. DE COLOR	lm	lm/W	IRC	COLOR	PESO	IP
w	1.6	100-240	0.5	50/60	2700K	55	34	>82	□	175 gr	IP 65
L7001-110					4000K	65	40				
L7001-610					2700K	55	34		■		
L7001-610					4000K	65	40				

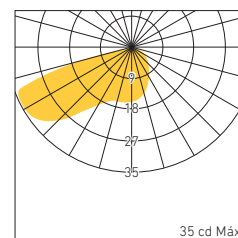
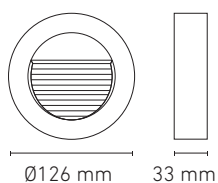

SW 20

CLAVE	W	V-	FP	Hz	TEMP. DE COLOR	lm	lm/W	IRC	COLOR	PESO	IP
L7002-110	1.6	100-240	0.5	50/60	2700K	55	34	>82	□	200 gr	IP 65
L7002-110					4000K	65	40				
L7002-610					2700K	55	34		■		
L7002-610					4000K	65	40				

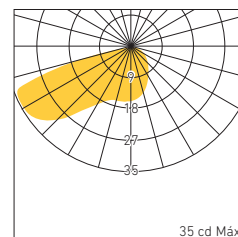
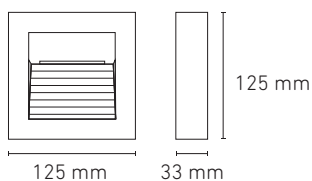

SW 30

CLAVE	W	V-	FP	Hz	TEMP. DE COLOR	lm	lm/W	IRC	COLOR	PESO	IP
L7003-110	1.6	100-240	0.5	50/60	2700K	55	34	>82	□	360 gr	IP 65
L7003-110					4000K	65	40				
L7003-610					2700K	55	34		■		
L7003-610					4000K	65	40				

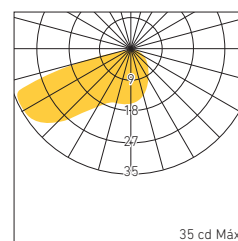
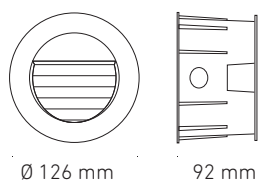

SW 40

CLAVE	W	V~	FP	Hz	TEMP. DE COLOR	lm	lm/W	IRC	COLOR	PESO	IP
L7004-110	1.6	100-240	0.5	50/60	2700K	55	34	>82	□	400 gr	IP 65
L7004-110					4000K	65	40				
L7004-610					2700K	55	34		■		
L7004-610					4000K	65	40				

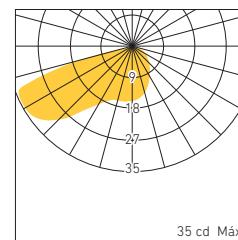
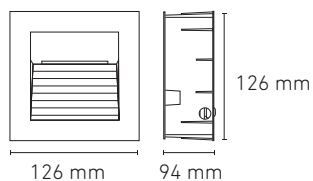

SW 50

CLAVE	W	V~	FP	Hz	TEMP. DE COLOR	lm	lm/W	IRC	COLOR	PESO	IP
L7005-110	1.6	100-240	0.5	50/60	2700K	55	34	>82	□	550 gr	IP 65
L7005-110					4000K	65	41				
L7005-610					2700K	55	34		■		
L7005-610					4000K	65	41				

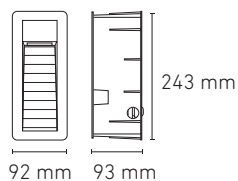

SW 60

CLAVE	W	V~	FP	Hz	TEMP. DE COLOR	lm	lm/W	IRC	COLOR	PESO	IP
L7006-110	2	100-240	0.5	50/60	2700K	80	40	>82	□	750 gr	IP 65
L7006-110					4000K	85	43				
L7006-610					2700K	80	40		■		
L7006-610					4000K	85	43				

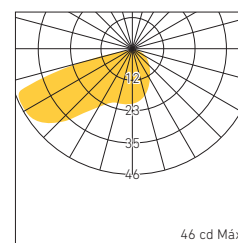
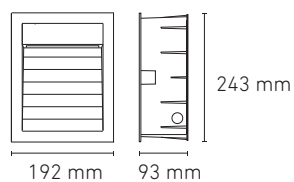

Categoría: MURO
 Familia: SERIE SW AL

SW 10 AL

CLAVE	W	V~	FP	Hz	TEMP. DE COLOR	lm	lm/W	IRC	COLOR	PESO	IP
L7020-610	2	100-305	0.9	50/60	2700K	55	34	>82	■	360 gr	IP 65
L7020-610					4000K	65	40				

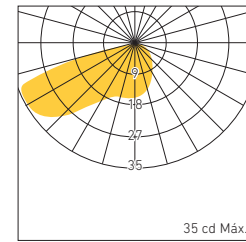
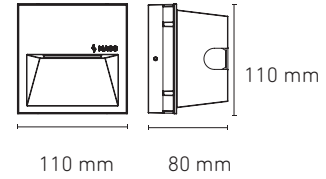

SW 20 AL

CLAVE	W	V~	FP	Hz	TEMP. DE COLOR	lm	lm/W	IRC	COLOR	PESO	IP
L7019-610	2	100-305	0.9	50/60	2700K	55	34	>82	■	400 gr	IP 65
L7019-610					4000K	65	40				

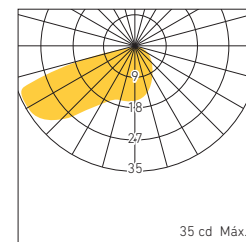
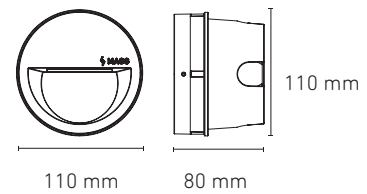

SW 30 AL

CLAVE	W	V~	FP	Hz	TEMP. DE COLOR	lm	lm/W	IRC	COLOR	PESO	IP
L7017-610	5	100-305	0.9	50/60	2700K	55	34	>82	■	550 gr	IP 65
L7017-610					4000K	65	41				

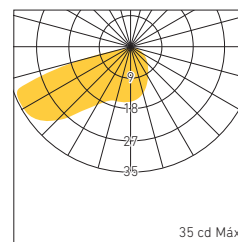
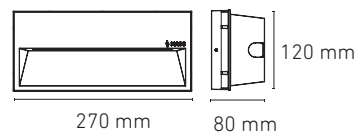

SW40 AL

CLAVE	W	V~	FP	Hz	TEMP. DE COLOR	lm	lm/W	IRC	COLOR	PESO
L7018-610	8.5	100-305	0.9	50/60	2700K	80	40	>82	■	750 gr
L7018-610					4000K	85	43			

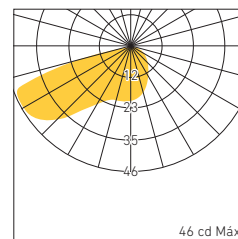
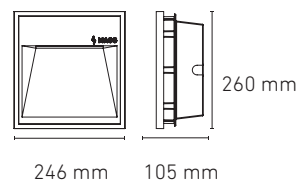



Ajustable



SERIES CUBO Y W II

Los muros son lienzos en blanco, a los cuales podemos integrar elementos que resaltan las texturas de estos, que sirvan de guías al usuario, de luz cálida y con la gran ventaja de poder jugar con los ángulos de apertura de su emisión, con formas básicas como el cubo y el cilindro conforman esta familia de luminarias selladas y de gran durabilidad para interiores y exteriores son las opciones que aquí se pueden encontrar.



Categoría: MURO
 Familia: SERIE CUBO

CUBO A

CLAVE	TAMAÑO	W	V-	FP	Hz	TEMP. DE COLOR	lm	lm/W	IRC	COLOR	PESO	IP
L7114-1E0	A8	5	100-240	0.5	50/60	3000K	250	50	≥82	□	394 gr	IP 65
L7111-1E0	A10	6.5					290	44			535 gr	
L7117-1E0	A12	12					720	60			828 gr	
L7112-1E0	A15	24					1440	60			1,192 gr	



Cubierta frontal Intercambiable.



Apertura manual de fácil acceso y manipulación.

*Colores especiales sobre pedido.
 *Haz de Luz unidireccional, opcional.

A8

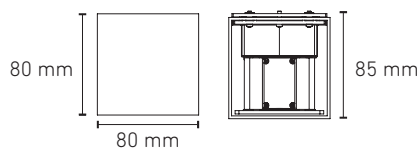

A10

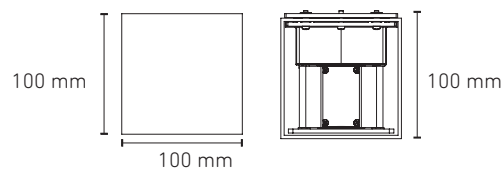

A12

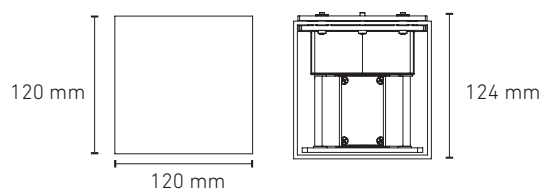

A15

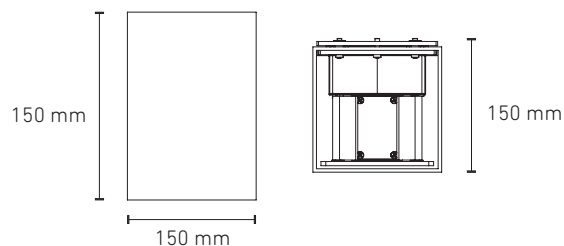

Categoría: MURO
 Familia: SERIE W II

W II

CLAVE	TAMAÑO	W	V-	FP	Hz	TEMP. DE COLOR	lm	lm/W	IRC	COLOR	PESO	IP
L7121-1E0	80/80	5	100-240	0.5	50 / 60	3000K	250	50	≥82	□	413 gr	IP 65
L7124-1E0	100/100	6.5					290	44			566 gr	
L7126-1E0	120/120	12					60	720			836 gr	
L7128-1E0	150/150	24					1440	60			1,226 gr	



*Colores especiales sobre pedido.
 *Haz de Luz unidireccional, opcional.

Cubierta frontal Intercambiable.

Apertura manual de fácil acceso y manipulación.

80/80

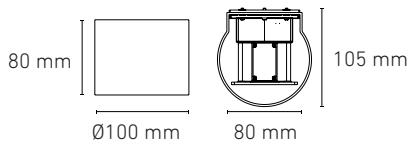

100/100

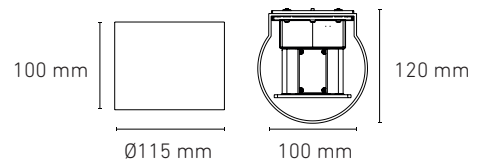

120/120

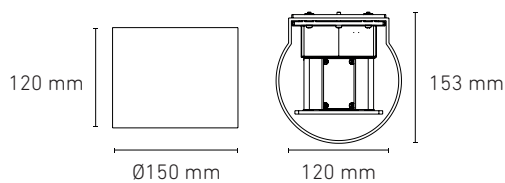

150/150

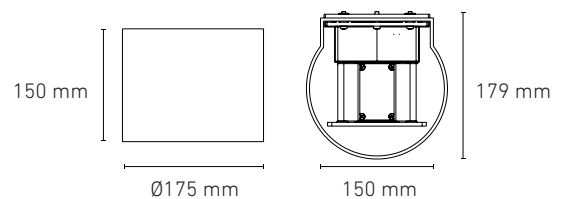





L Á M P A R A S — LED —

Las lámparas de LED lineales y de acento de MAGG, son ideales para la protección del ambiente, no solo por no contener mercurio, si no por combinar alta eficacia luminosa, largas horas de vida útil y bajo consumo energético. Son excelentes para ser integradas a sensores, y en algunos casos con sistemas de atenuación.

Categoría: LÁMPARAS

Familia: AR111 LED

VERSIÓN FIJA

CLAVE	W	V~	TEMP. DE COLOR	lm	lm/W	ÁNGULO	IRC	COLOR	PESO	IP
F5040-3E3	10.5	12	3000K	840	84	18°	>82	■	120 gr	IP 50
F5040-1E3								□		
F5040-3I3								■		
F5040-1I3								□		
F5040-3E9			4000K	900	90	45°		■		
F5040-1E9								□		
F5040-3I9								■		
F5040-1I9								□		

VERSIÓN ATENUABLE

CLAVE	W	V~		TEMP. DE COLOR	lm	lm/W	ÁNGULO	IRC	COLOR	PESO	IP
F5041-3E3	10.5	12	Por Fase	3000K	840	84	18°	>82	■	120 gr	IP 50
F5041-1E3									□		
F5041-3I3									■		
F5041-1I3									□		
F5041-3E9				4000K	900	90	45°		■		
F5041-1E9									□		
F5041-3I9									■		
F5041-1I9									□		

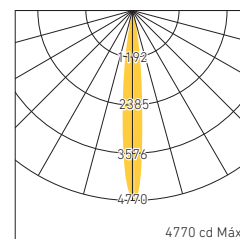
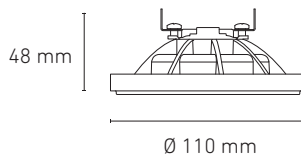

18°

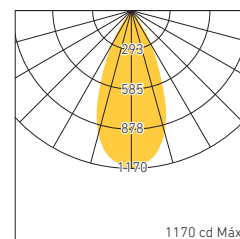

45°

Usar transformador electrónico no incluido clave: B0174-200 máximo tres lámparas por cada transformador.

Categoría: **LÁMPARAS**
 Familia: **LÁMPARAS LINEALES**

T5 LED

CLAVE	W	V~	FP	Hz	TEMP. DE COLOR	lm	lm/W	IRC	PANTALLA	PESO	IP
F5056-010	9	100-305	>0.5	50/60	4000K	980	104	≥82	Opalina	80 gr	IP 50
F5056-030					6000K						
F5045-010	18				4000K	1960	180			162 gr	
F5045-030					6000K						

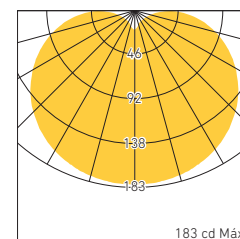
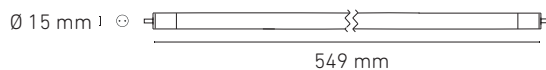

T8 LED

CLAVE	MODELO	W	V~	FP	Hz	TEMP. DE COLOR	lm	lm/W	IRC	PANTALLA	PESO	IP
F5146-010	BÁSICO	16	100-240	>0.5	50/60	4000K	1650	102	≥70	Transparente	200 gr	IP 50
F5146-030						6000K						
F5147-010						1570	187	Opalina				
F5147-030										6000K		
F5142-010	STD					1720	113	≥80	Transparente			
F5142-030										6000K		
F5141-010						1800	103		Opalina			
F5141-030										6000K		
F5141-0E0	1660	100	Opalina									
F5142-0E0				3000k	100							
F5152-010	PREMIUM	18	100-305	>0.9	50/60	4000K	2200	122	≥80	Opalina	200 gr	IP 50
F5152-030						6000K						

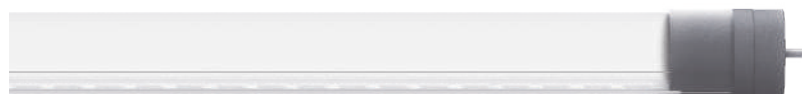

BÁSICO

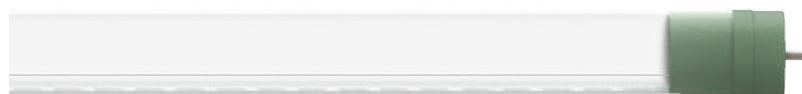

ESTANDAR

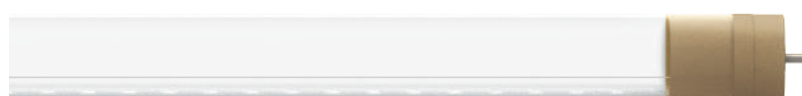

PREMIUM

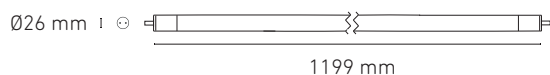

T8 LED 2400 FA8

CLAVE	W	V-	FP	Hz	TEMP. DE COLOR	lm	lm/W	IRC	PANTALLA	PESO	IP
F5158-010	36	100-240	>0.9	50/60	4000K	4120	114	≥82	Opalina	585 gr	IP 50
F5158-030					6000K						

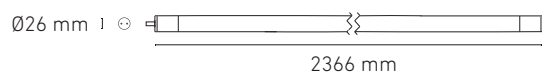
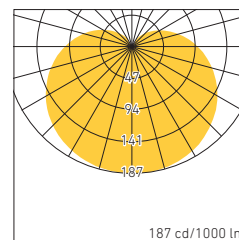

T8 LED 2400 BI PIN

CLAVE	W	V-	FP	Hz	TEMP. DE COLOR	lm	lm/W	IRC	PANTALLA	PESO	IP
F5159-010	36	100-240	>0.5	50/60	4000K	4120	114	≥82	Opalina	585 gr	IP 50
F5159-030					6000K						

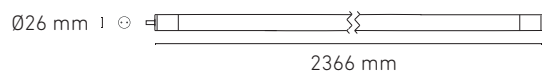
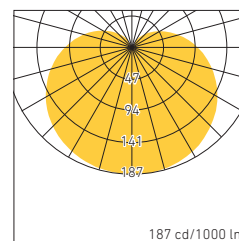



La correcta iluminación en exteriores ya sea para aplicación arquitectónica, comercial e industrial permite crear un ambiente seguro y confortable en el que los usuarios de dichas áreas pueden desarrollar toda clase de actividades teniendo como objetivo en común el bienestar y la productividad.

En Magg contamos con un amplio conjunto de luminarias con una construcción totalmente sellada, materiales altamente resistentes a climas extremos y máxima eficiencia lumínica, que dan como resultado una gran variedad de soluciones capaces de cubrir las más altas expectativas.

EMPOTRADOS A PISO

PÁGINA

SERIE EP

EMPOTRAR



EP 60 SOFT



EP 60



EP 60 SQ SOFT



EP 60 SQUARE



EP 100



EP 120



EP 170



EP 220-25

..... 181-187

SIDE EMITTER

EMPOTRAR



SIDE EMITTER 1 S



SIDE EMITTER 2 S



SIDE EMITTER 12 S

..... 190-191

BOLLARDS

VENECIA

SOBREPONER



VENECIA DOMO 200



VENECIA DOMO 450



VENECIA DOMO 800

..... 194-195

PROYECTORES

SERIE KR

SOBREPONER



KR 5



KR 10



KR 35



KR 55



KR 80



KR 130

..... 198-200

SERIE KR FLAT
SOBREPONER



KR FLAT 35



KR FLAT 70

..... 201-202

SEGURIDAD

SERIE WALLPACK
SOBREPONER



WALLPACK 80

..... 203

CITI 23
SOBREPONER



CITI 23

..... 206

ALUMBRADO PÚBLICO

SERIE CITI
SOBREPONER



CITI 35



CITI 55



CITI 100

..... 207-211





SERIE EP

Las luminarias diseñadas para exterior deben ser resistentes, estéticas, eficientes y con un buen CRI (Índice de Reproducción de Color), nuestra familia de EP contiene todas estas consideraciones, al utilizarlos podremos enfatizar, iluminar y generar distintos planos, utilizando las diferentes variantes de apertura con haz de luz limpio, temperatura de color y distintos difusores. Por estas cualidades y la facilidad de su instalación la familia EP resulta ser una excelente opción para espacios al aire libre.

NUEVA —SERIE EP—

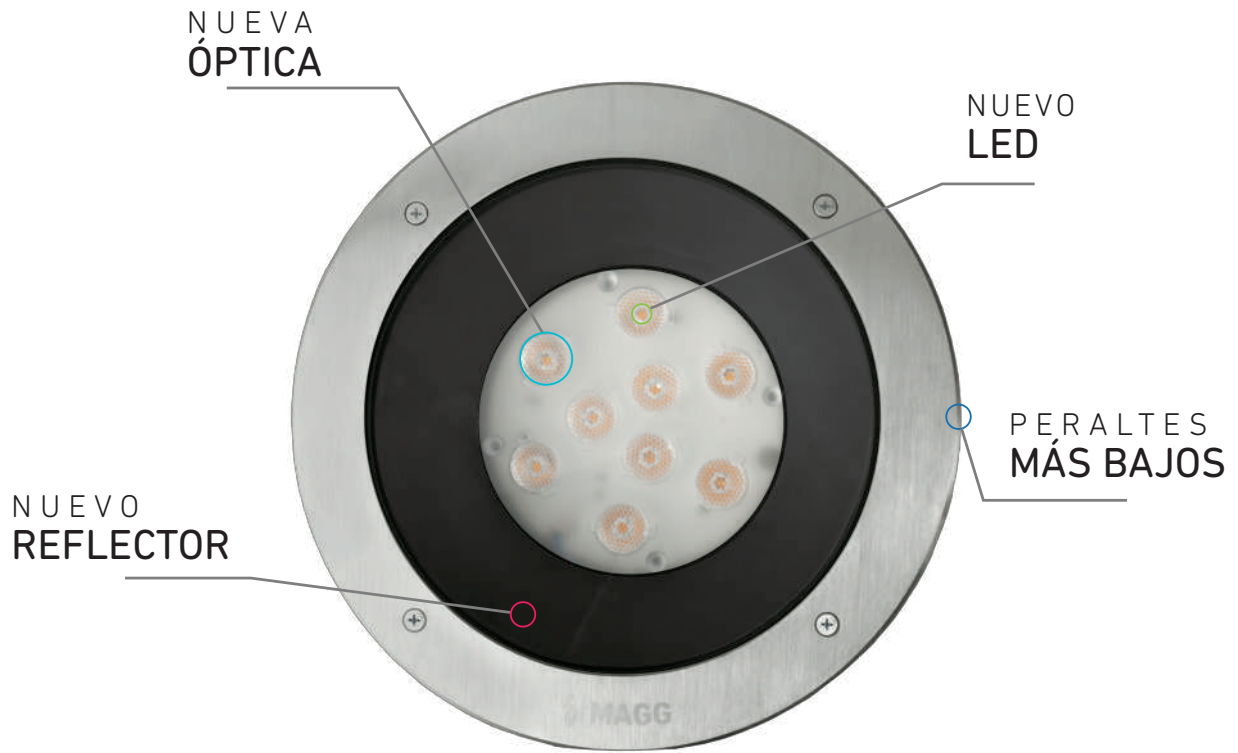

LA IMPORTANCIA DE TENER UN HOUSING EN LA INSTALACIÓN

Una de las principales propiedades de la familia EP es el uso de housing para la instalación.

Tiene la facilidad de instalarse durante la obra, dejándolo ahogado en el proceso de obra negra.

Incluye tapas inferior y superior, asegurando quede limpio, dejando la instalación lista, para que al final de este proceso la luminaria no se maltrate.

Este housing tiene la finalidad de una caja de registro, de la cual puede llegar el conexionado y derivar a otros luminarios.

El housing queda ahogado en la instalación, lo cual facilita el cambio de luminario por mantenimiento, con éste sistema se puede reemplazar la luminaria, no es necesario romper ni maltratar el piso en la instalación.

Haciendo una instalación de manera mas limpia y sencilla.

Se recomienda el uso de los conectores " T " - " I " , para una instalación mas profesional, garantizando la hermeticidad hacia el interior del luminario, evitando la entrada de humedad.

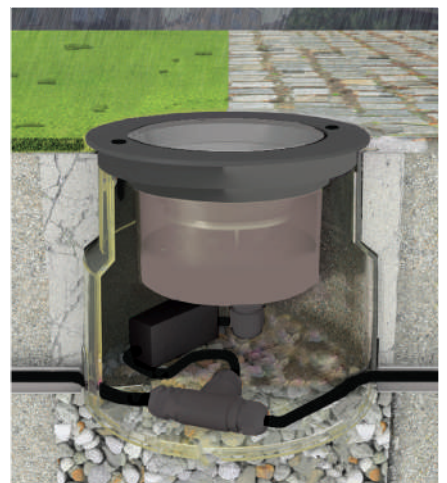
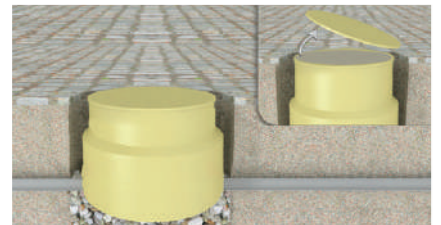

Categoría: PISO
 Familia: SERIE EP

EP 60 SOFT

CLAVE	W	V~	FP	Hz	TEMP. DE COLOR	lm	lm/W	IRC	PESO	IP
L7303-910	1.2	100-240	0.5	50/60	2700K	6	5	>82	110 gr	IP 65

EP 60

CLAVE	W	V~	FP	Hz	TEMP. DE COLOR	lm	lm/W	ÁNGULO	IRC	PESO	IP
L7301-913	2	100-240	0.5	50/60	2700K	90	45	18°	>82	110 gr	IP 65
L7301-919						74	37	45°			

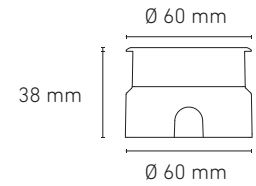

EP 60 SOFT



EP 60

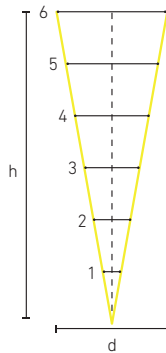

18°		
h (m)	d (m)	E (lx)
6	2.00	7
5	1.70	12
4	1.35	18
3	1.00	30
2	0.70	70
1	0.35	260

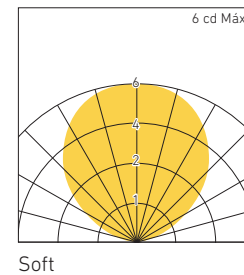

Soft

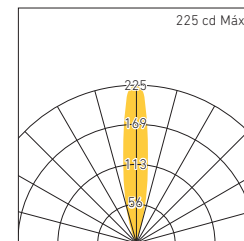

18° Referencia a 2700K

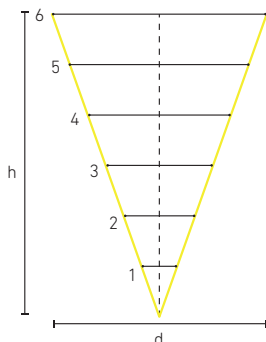

45°		
h (m)	d (m)	E (lx)
6	4.20	2
5	3.50	3
4	2.80	4
3	2.10	8
2	1.40	18
1	0.70	72

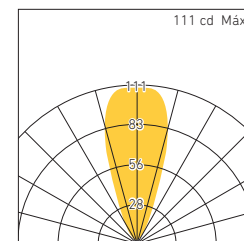

45° Referencia a 2700K

EP 60 SQUARE SOFT

CLAVE	W	V~	FP	Hz	TEMP. DE COLOR	lm	lm/W	IRC	PESO	IP
L7302-910	1.2	100-240	0.5	50/60	2700K	6	5	>82	120 gr	IP 65

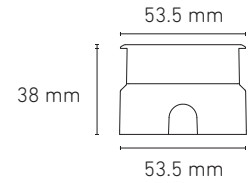

EP 60 SQUARE

CLAVE	W	V~	FP	Hz	TEMP. DE COLOR	lm	lm/W	ÁNGULO	IRC	PESO	IP
L7302-913	2	100-240	0.5	50/60	2700K	90	45	18°	>82	120 gr	IP 65
L7302-919						74	37	45°			



EP 60 SQUARE SOFT



EP 60 SQUARE

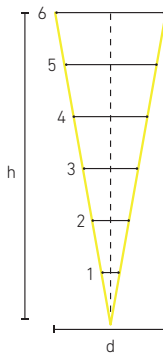

18°		
h (m)	d (m)	E (lx)
6	2.00	7
5	1.70	12
4	1.35	18
3	1.00	30
2	0.70	70
1	0.35	260

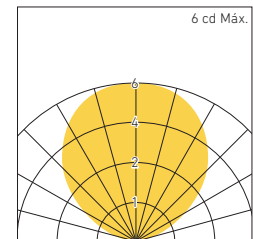

Soft

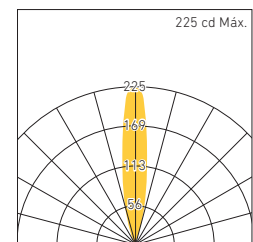

18° Referencia a 2700K

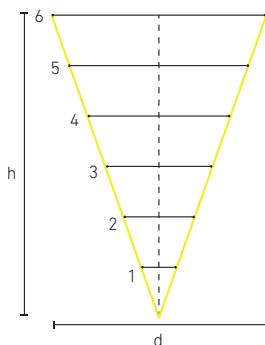

45°		
h (m)	d (m)	E (lx)
6	4.20	2
5	3.50	3
4	2.80	4
3	2.10	8
2	1.40	18
1	0.70	72

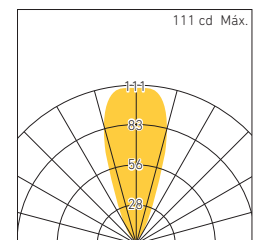

45° Referencia a 2700K

CLAVE	W	V-	FP	Hz	TEMP. DE COLOR	lm	lm/W	ÁNGULO	IRC	COLOR	PESO	IP
L7310-913	3.8	100-305	>0.8	50/60	2700K	260	74	18°	>82	Inox.	400gr	IP 65
L7310-91M						244	69	46°				
L7310-913					4000K	260	74	18°				
L7310-91M						244	69	46°				
L7310-613					4000K	2700K	280	80		18°		
L7310-61M							262	75		46°		
L7310-613						2700K	280	80		18°		
L7310-61M							262	75		46°		



- Nueva óptica
- Nuevo led
- Nuevo reflector
- Nuevo tamaño

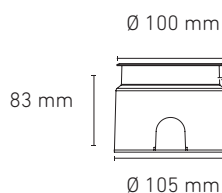

Altura nueva

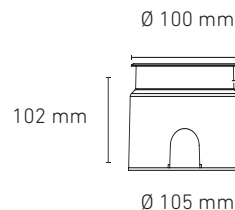

Altura anterior

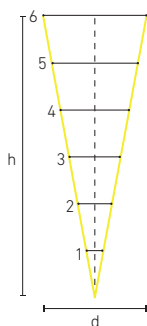

EP 100 - 18°		
h (m)	d (m)	E (lx)
6	1.9	30
5	1.6	40
4	1.3	65
3	1.0	115
2	0.6	255
1	0.3	920

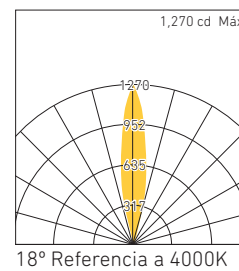

18° Referencia a 4000K

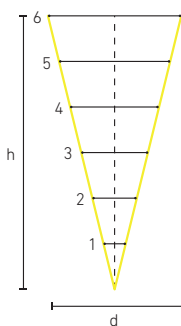

EP 100 - 46°		
h (m)	d (m)	E (lx)
6	5.0	9
5	4.2	13
4	3.4	21
3	2.5	37
2	1.7	80
1	0.8	320

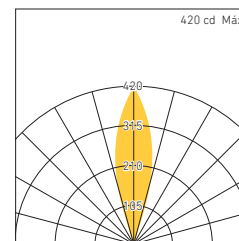

46° Referencia a 4000K

EP 120

CLAVE	W	V~	FP	Hz	TEMP. DE COLOR	lm	lm/W	ÁNGULO	IRC	COLOR	PESO	IP
L7320-913	8.5	100-305	>0.8	50/60	2700K	625	78	18°	>82	Inox.	620 gr	IP 65
L7320-91M						573	71	46°				
L7320-913					4000K	625	78	18°				
L7320-91M						573	71	46°				
L7320-613					4000K	672	84	18°		■		
L7320-61M						616	77	46°				
L7320-613						672	84	18°				
L7320-61M						616	77	46°				



Nueva óptica

Nuevo led

Nuevo reflector

Nuevo tamaño

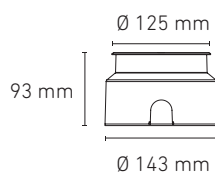

Altura nueva

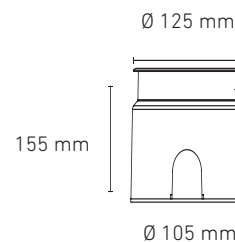

Altura anterior

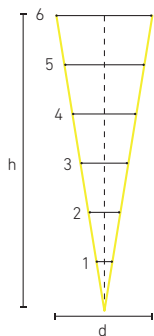

EP 120 - 18°		
h (m)	d (m)	E (lx)
6	1.9	70
5	1.6	100
4	1.3	155
3	1.0	270
2	0.6	610
1	0.3	2220

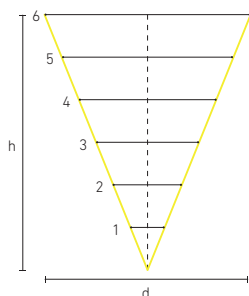
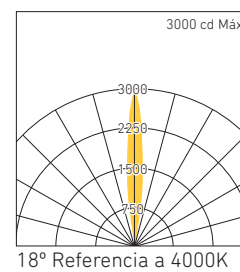

EP 120 - 46°		
h (m)	d (m)	E (lx)
6	5.0	20
5	4.2	30
4	3.4	50
3	2.5	87
2	1.7	190
1	0.8	750

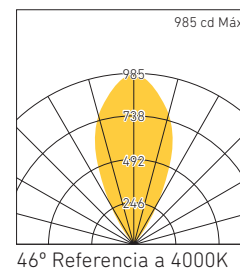

EP 170

CLAVE	W	V-	FP	Hz	TEMP. DE COLOR	lm	lm/W	ÁNGULO	IRC	PESO	IP
L7330-913	13	100-305	>0.8	50/60	2700K	1097	84	18°	>82	1,140 gr	IP 65
L7330-91M						1023	78	46°			
L7330-913					4000K	1180	90	18°			
L7330-91M						1100	84	46°			



- Nueva óptica
- Nuevo led
- Nuevo reflector
- Nuevo tamaño

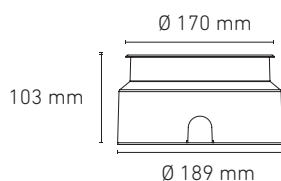

Altura nueva

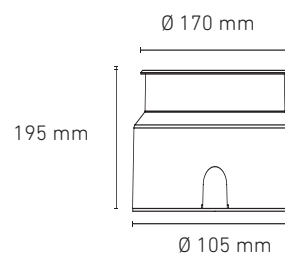

Altura anterior

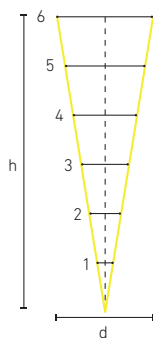

h (m)	d (m)	E (lx)
6	1.9	120
5	1.6	170
4	1.3	270
3	1.0	485
2	0.6	1070
1	0.3	3900

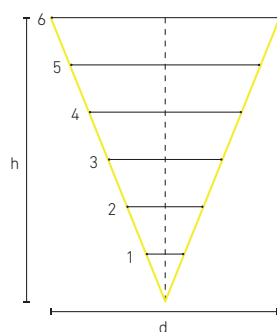
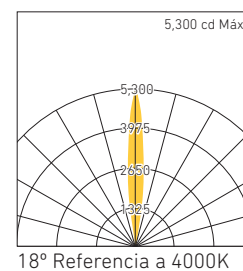

h (m)	d (m)	E (lx)
6	5.0	40
5	4.2	56
4	3.4	88
3	2.5	155
2	1.7	350
1	0.8	1340

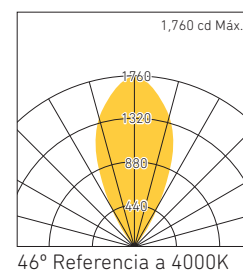

EP 220

CLAVE	W	V-	FP	Hz	TEMP. DE COLOR	lm	lm/W	ÁNGULO	IRC	PESO	IP
L7340-913	22	100-305	>0.9	50/60	2700K	1795	82	18°	>82	1,920 gr	IP 65
L7340-91M						1618	73	46°			
L7340-913					4000K	1930	88	18°			
L7340-91M						1740	79	46°			



- Nueva óptica
- Nuevo led
- Nuevo reflector
- Nuevo tamaño

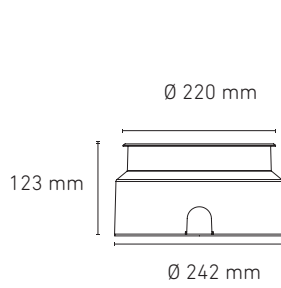

Altura nueva

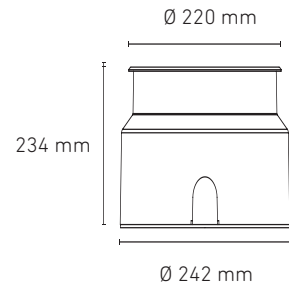

Altura anterior

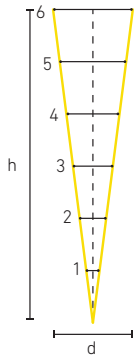

EP 220 - 18°		
h (m)	d (m)	E (lx)
6	1.9	200
5	1.6	285
4	1.3	445
3	1.0	790
2	0.6	1750
1	0.3	6390

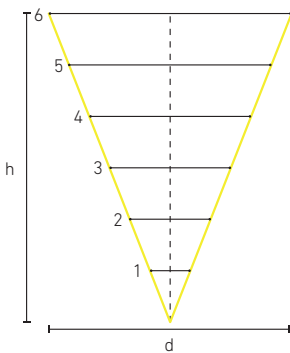
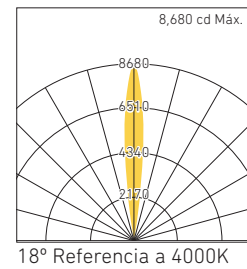

EP 220 - 46°		
h (m)	d (m)	E (lx)
6	5.0	60
5	4.2	85
4	3.4	140
3	2.5	245
2	1.7	550
1	0.8	2120

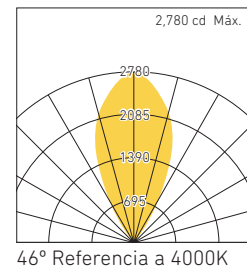

EP 220PLUS

CLAVE	W	V-	FP	Hz	TEMP. DE COLOR	lm	lm/W	ÁNGULO	IRC	PESO	IP
L7341-913	29	100-305	>0.9	50/60	2700K	2240	77	18°	>82	2,400 gr	IP 65
L7341-91M						2050	71	46°			
L7341-913					4000K	2407	83	18°			
L7341-91M						2204	76	46°			



Nueva óptica

Nuevo led

Nuevo reflector

Nuevo tamaño

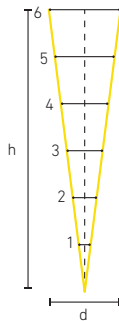
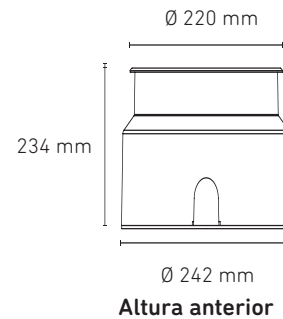
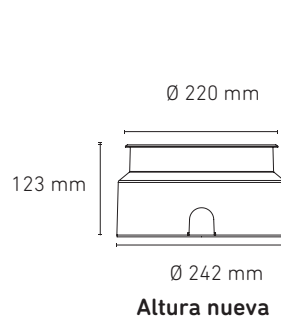

EP 220 PLUS 18°		
h (m)	d (m)	E (lx)
6	1.9	245
5	1.6	360
4	1.3	560
3	1.0	985
2	0.6	2180
1	0.3	7970

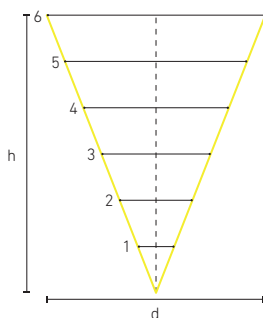
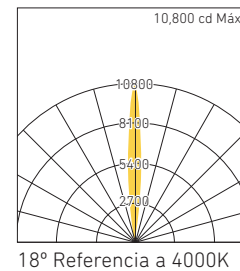

EP 220 PLUS 46°		
h (m)	d (m)	E (lx)
6	5.0	75
5	4.2	110
4	3.4	175
3	2.5	310
2	1.7	695
1	0.8	2680

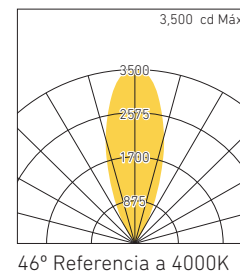



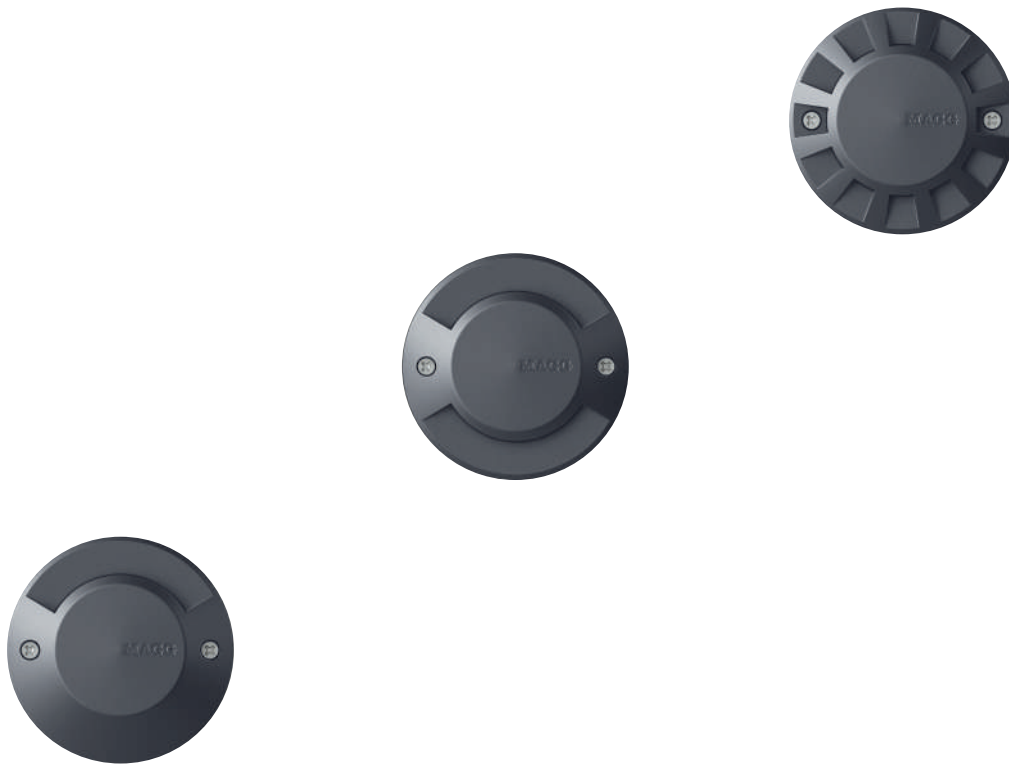

SIDE EMITTER

Fuertes, aluminio resistente a la corrosión, sellado contra polvo y humedad, esta serie de luminarias te puede acompañar a través de los recorridos exteriores y/o interiores del proyecto. Con un excelente terminado super resistente y la posibilidad de generar diferentes patrones en piso con las 3 formas distintas en sus tapas, esta familia ofrece gran variedad de usos incluso para tránsito ligero.

Categoría: PISO
 Familia: SIDE EMITER



SIDE EMITTER 1 S

CLAVE	W	V~	FP	Hz	TEMP. DE COLOR	lm	lm/W	IRC	COLOR	PESO	IP
L7350-610	2	100-240	0.5	50/60	2700K	130	65	>82	■	335 gr	IP 65
L7350-6B0					AZUL	-	-	-			

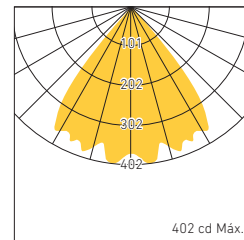
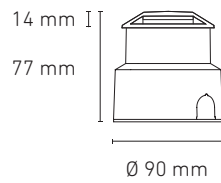

SIDE EMITTER 2 S

CLAVE	W	V~	FP	Hz	TEMP. DE COLOR	lm	lm/W	IRC	COLOR	PESO	IP
L7351-610	2	100-240	0.5	50/60	2700K	130	65	>82	■	335 gr	IP 65
L7351-6B0					AZUL	-	-	-			

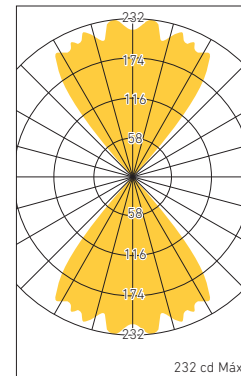
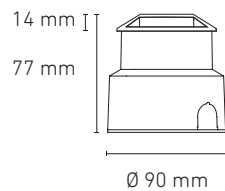

SIDE EMITTER 12 S

CLAVE	W	V~	FP	Hz	TEMP. DE COLOR	lm	lm/W	IRC	COLOR	PESO	IP
L7352-610	2	100-240	0.5	50/60	2700K	130	53	>82	■	320 gr	IP 65
L7352-6B0					AZUL	-	-	-			

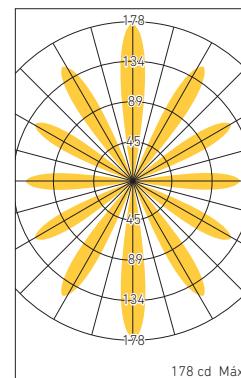
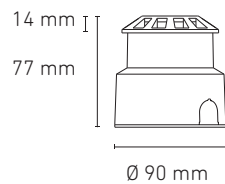





BOLLARD

En cuestiones de equipamiento urbano, la familia de bolardos que se han desarrollado en Magg, cuentan con una tecnología de punta perfectamente aplicada, los materiales resistentes al exterior, sistema de montaje fuerte que permite reducir tiempos de instalación y fácil mantenimiento. Además de una emisión de luz radial para iluminar caminos y pasos peatonales con gran amplitud. Luminarias que se aplican con gran facilidad y que se mimetizan con el medio urbano de manera excelente.

Categoría: BOLLARDS
 Familia: SERIE VENECIA

VENECIA DOMO 200

CLAVE	W	V~	FP	Hz	TEMP. DE COLOR	lm	lm/W	IRC	COLOR	PESO	IP
L7630-6E0	6.5	100-305	0.5	50/60	3000K	130	20	≥82	■	450 gr	IP 65
L7630-6H0					5000K	220	34	70			

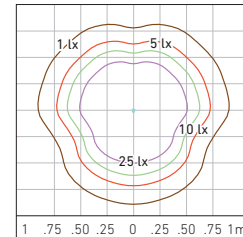
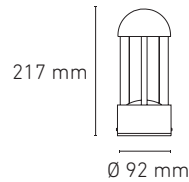

VENECIA DOMO 450

CLAVE	W	V~	FP	Hz	TEMP. DE COLOR	lm	lm/W	IRC	COLOR	PESO	IP
L7635-6E0	6	100-305	0.5	50/60	3000K	120	20	≥82	■	1760 gr	IP 65
L7635-640					5700K	230	38	70			

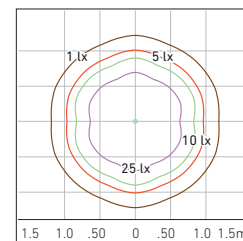
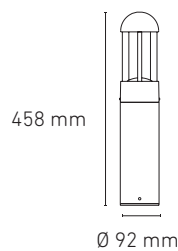

VENECIA DOMO 800

CLAVE	W	V~	FP	Hz	TEMP. DE COLOR	lm	lm/W	IRC	COLOR	PESO	IP
L7640-6E0	6	100-305	0.5	50/60	3000K	120	20	≥82	■	2745 gr	IP 65
L7640-640					5700K	230	38	70			

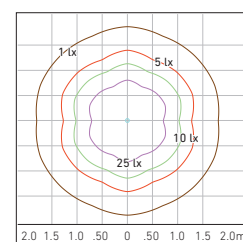
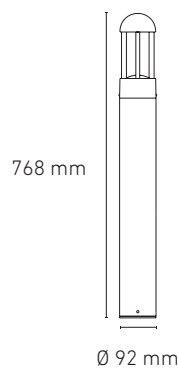

Categoría: BOLLARDS
Familia: SERIE VENEZIA



EXTERIOR



120°



180°

SERIES

KR, KR FLAT

Alta potencia y una controlada emisión lumínica, así como, la diversidad de aperturas de haz de luz y sistemas de fijación sencillos y a la vez robustos, hacen de esta familia una herramienta de diseño fundamental. El alto índice de protección al ingreso (IP65) y protección a impactos, proporciona la confianza necesaria para utilizarlos en cualquier medio ambiente.



Categoría: PROYECTORES

Familia: SERIE KR

KR 5

CLAVE	W	V~	FP	Hz	TEMP. DE COLOR	lm	lm/W	ÁNGULO	IRC	COLOR	PESO	IP
L7480-6E5	5	100-240	0.5	50/60	3000K	350	70	24°	≥90	■	350 gr	IP 65
L7480-6EF						330	66	50°				
L7480-635					6000K	380	76	24°				
L7480-63F						350	70	50°				

PEDESTAL

CLAVE	ALTURA	COLOR
P0364-600	7 CMS.	■
P0365-600	20 CMS.	
P0366-600	45 CMS.	

(Venta por separado)

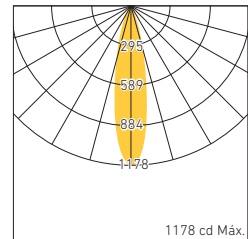
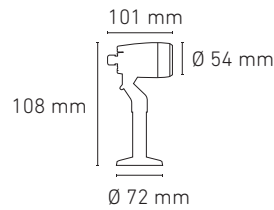

24°

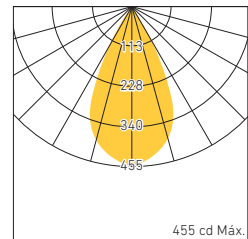

50°



KR 10

CLAVE	W	V~	FP	Hz	TEMP. DE COLOR	lm	lm/W	ÁNGULO	IRC	COLOR	PESO	IP
L7445-6E5	10	100-305	0.5	50/60	3000K	400	40	24°	≥90	■	520 gr	IP 65
L7445-6EF						400	40	50°				
L7445-635					6000K	450	45	24°				
L7445-63F						450	45	50°				

PEDESTAL

CLAVE	ALTURA	COLOR
P0322-600	7 CMS.	■
P0323-600	20 CMS.	
P0324-600	45 CMS.	

(Venta por separado).

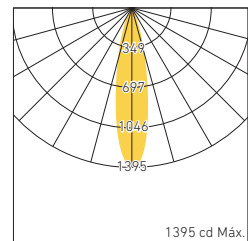
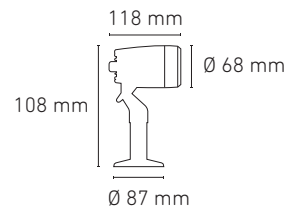

24°

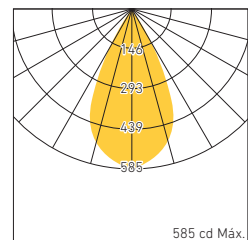

50°



KR 35

CLAVE	W	V-	FP	Hz	TEMP. DE COLOR	lm	lm/W	IRC	COLOR	PESO	IP
L7451-6E0	35	100-305	≥0.9	50/60	3000K	3300	94	≥80	■	840 gr	IP 65
L7451-630					6000K	3500	100				

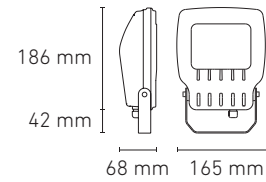
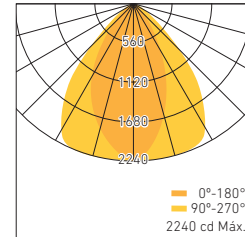

KR 55

CLAVE	W	V-	FP	Hz	TEMP. DE COLOR	lm	lm/W	IRC	COLOR	PESO	IP
L7452-6E0	55	100-305	≥0.9	50/60	3000K	3900	70	≥80	■	1,980 gr	IP 65
L7452-630					6000K	4100	75				

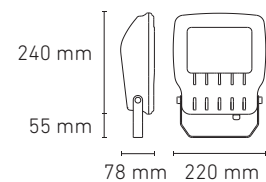
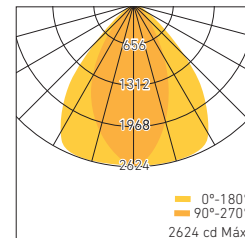

KR 80

CLAVE	W	V-	FP	Hz	TEMP. DE COLOR	lm	lm/W	IRC	COLOR	PESO	IP
L7453-6E0	80	100-305	≥0.9	50/60	3000K	7000	88	≥80	■	3,300 gr	IP 65
L7453-630					6000K	7500	93				

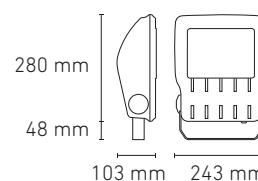
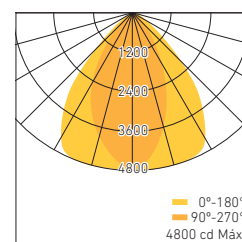

KR 130

CLAVE	W	V-	FP	Hz	TEMP. DE COLOR	lm	lm/W	IRC	COLOR	PESO	IP
L7454-6E0	130	100-305	≥0.9	50/60	3000K	11300	87	≥80	■	5,100 gr	IP 65
L7454-630					6000K	12800	98				

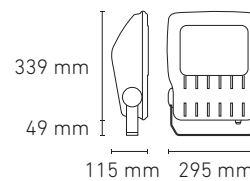
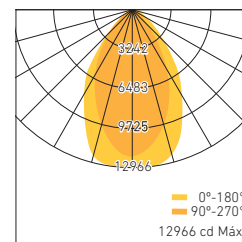

Categoría: PROYECTORES
 Familia: SERIE KR FLAT

KR FLAT 35

CLAVE	W	V-	FP	Hz	TEMP. DE COLOR	lm	lm/W	ÁNGULO	IRC	COLOR	PESO	IP
L7423-61E	8	100-305	0.5	50/60	2700K	560	70	15°x40°	>82	■	400 gr	IP 65
L7423-61H						480	60	7°				
L7423-615						560	70	12°				
L7423-619						520	65	45°				
L7423-61E					4000K	648	81	15°x40°				
L7423-61H						560	70	7°				
L7423-615						650	81	12°				
L7423-619						600	75	45°				

ACCESORIOS

CLAVE	ACCESORIOS
P0120-000	Estaca

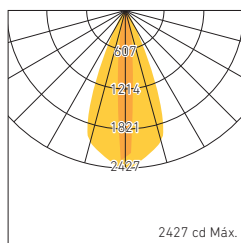
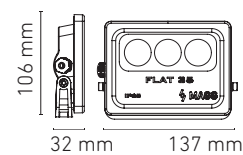

15°x40°

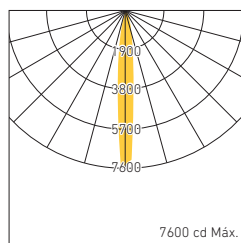

7°

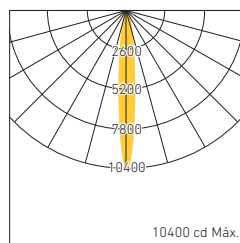

12°

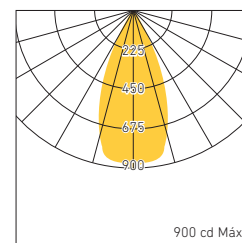

45°

KR FLAT 70

CLAVE	W	V-	FP	Hz	TEMP. DE COLOR	lm	lm/W	ÁNGULO	IRC	COLOR	PESO	IP	
L7424-61E	12	100-305	0.5	50/60	2700K	840	70	15°x40°	>82	■	510 gr	IP 65	
L7424-61H						720	60	7°					
L7424-615						840	70	12°					
L7424-619						690	57	45°					
L7424-6IE					4000K	7°							
L7424-6IH							840	70					7°
L7424-6I5							970	80					12°
L7424-6I9							804	75					45°

ACCESORIOS

CLAVE	ACCESORIOS
P0120-000	Estaca

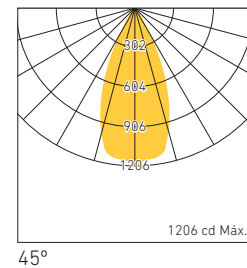
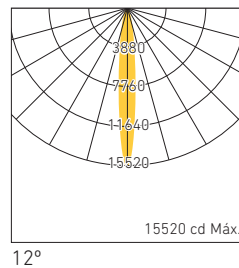
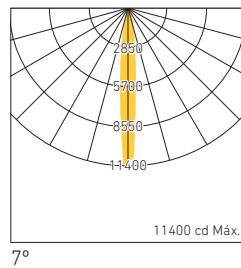
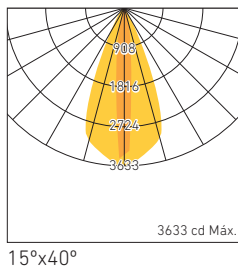
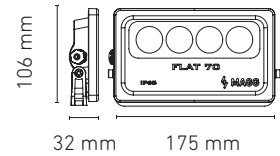

Categoría: SEGURIDAD
 Familia: SERIE WALLPACK

WALLPACK 80 / 50

CLAVE	W	V~	FP	Hz	TEMP. DE COLOR	lm	lm/W	IRC	COLOR	PESO	IP
L7265-630	80	100-305	>0.9	50/60	6000K	7600	95	≥82	■	1,540 gr	IP 65
L7266-630	50					4950	99				

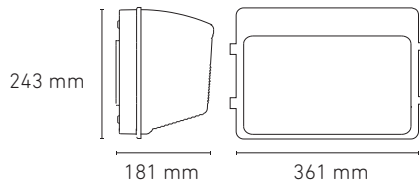

WALLPACK 80

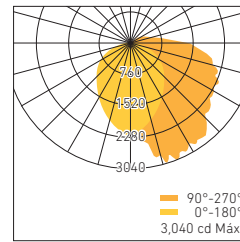

WALLPACK 50

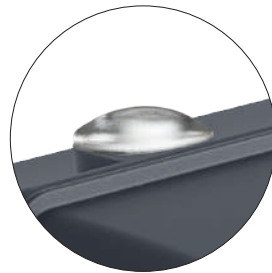
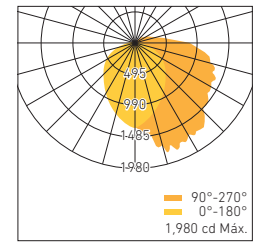

- Foto-sensor opcional. Consultar ventas







SERIE CITI

La familia Citi está diseñada para cumplir los estándares de iluminación para vías públicas. Su delgado diseño, como resultado de la máxima eficiencia de componentes, los LEDs de última tecnología y su perfecta ingeniería óptica hacen que Citi sea una familia de luminarias sencillas, pero a la vez vanguardistas dentro de las tipologías de este mercado. Estas luminarias cuentan con un excelente desempeño al poder instalarse a una distancia interpostal de hasta 4 veces la altura de montaje.

Categoría: SEGURIDAD

Familia: CITI 23

CLAVE	W	V~	FP	Hz	TEMP. DE COLOR	lm	lm/W	IRC	COLOR	PESO	IP
L7590-6H0	23	100-305	0.5	50/60	5000K	2050	89	>70	■	1,000 gr	IP 65

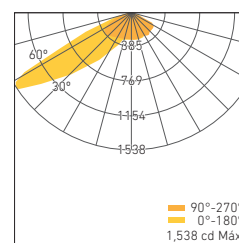
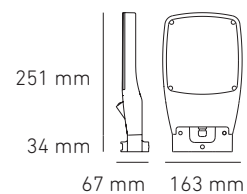

LUMINARIA INDIVIDUAL

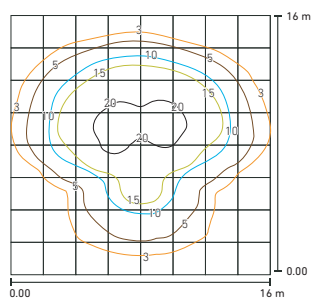

ARREGLO DE 3 LUMINARIAS

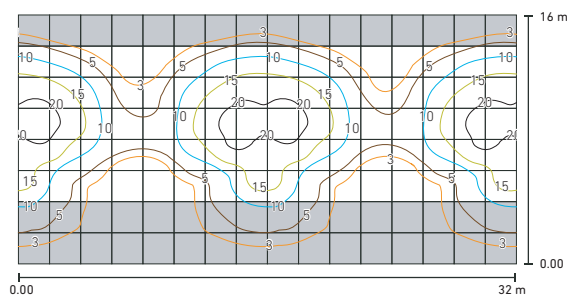

Ancho de Calle: 10 m
 Altura de Montaje: 4 m
 Distancia Interpostal: 16 m
 E max. 23 lx
 E prom. 10 lx
 E min. 2 lx
 Uniformidad: 5

Categoría: ALUMBRADO PÚBLICO

Familia: CITI 35

CLAVE	W	V-	FP	Hz	TEMP. DE COLOR	lm	lm/W	IRC	ÓPTICA	COLOR	PESO	IP
L7716-6H0	35	100-240	>0.9	50/60	5000K	3850	110	>70	Tipo III M	■	1,680 gr	IP 65

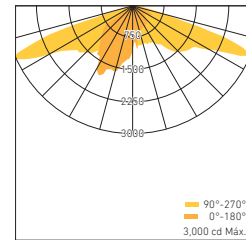
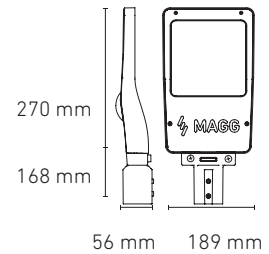

LUMINARIA INDIVIDUAL

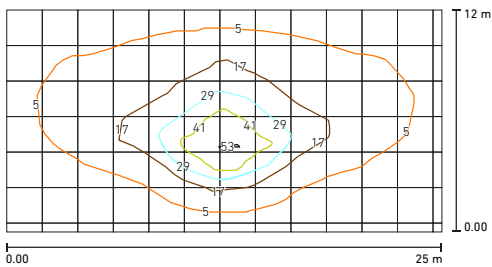

- Ancho de Calle: 7 m
- Altura de Montaje: 5.5 m
- Distancia Interpostal: 30 m
- E max. 38 lx
- E prom. 12 lx
- E min. 2.3 lx
- Uniformidad: 5.2

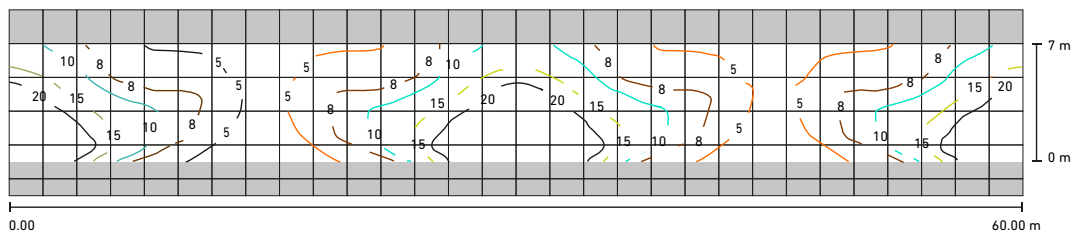

NOTA

EJEMPLO DE REFERENCIA.

Las dimensiones de la calle están basadas en el protocolo de pruebas PAESE Anexo 1 Croquis B para vías Secundarias, cumpliendo con los valores establecidos en la tabla X.

—FAMILIA CITI—

La familia Citi 55 y Citi 100 cuentan con 3 niveles de producto, los cuales se distinguen principalmente por su eficiencia que como resultado nos dá una diferencia en flujo luminoso con la misma potencia.

Dichas diferencias en eficiencia, se deben a que los componentes electrónicos con los que están fabricados ofrecen distintas prestaciones sin demeritar la calidad y durabilidad del producto.

BÁSICO: Ésta luminaria le brinda una eficiencia de 97 lm/W y buenas prestaciones comparadas con luminarias de la competencia, al mejor costo.

STANDARD: Ésta versión cuenta con un flujo luminoso mayor al básico y eficiencia de 105 lm/W, superando el standard del mercado para ésta gama de productos. Además de un driver multi voltaje que puede operar a una tensión de 100 a 305V.

PRIME: Ésta luminaria le brinda las más altas prestaciones con una eficiencia de 115 lm/W reales y driver multivoltaje.



CITI 55



CITI 100

Óptica: Tipo IES III-M: Diseñada para la mayoría de las calles. La luminaria bien posicionada en altura de montaje y distancia interpostal puede cumplir a la perfección los niveles de Iluminancia (lx) y uniformidad de acuerdo a las normas.

PCB tipo circundante: Éste nuevo PCB mejora el rendimiento de la luminaria, ya que ayuda a disipar mejor la temperatura en los LEDs, a reflejar más la luz incidente y a aumentar el flujo luminoso total.

Nueva generación de Drivers multivoltaje: La tecnología desarrollada por Magg da origen a una gama de productos con un rango de prestaciones en sus drivers que favorecen la eficiencia, durabilidad y utilización en proyectos a sus distintos niveles.



CITI 55

CLAVE	W	V~	FP	Hz	THD	TEMP. DE COLOR	lm	lm/W	IRC	ÓPTICA	COLOR	PESO	IP
L7501-6H0	55	100-240	>0.9	50/60	13%	5000K	5600	105	≥70	Tipo III M	■	3,800 gr	IP 65

Opcional

L7592-6H0	55	100-305	>0.9	50/60	13%	5000K	5600	105	≥70	Tipo III M	■	3,800 gr	IP 65
-----------	----	---------	------	-------	-----	-------	------	-----	-----	------------	---	----------	-------

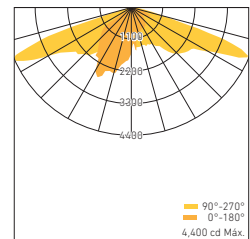
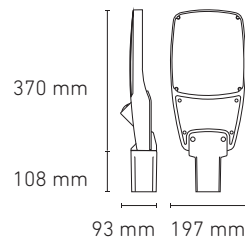

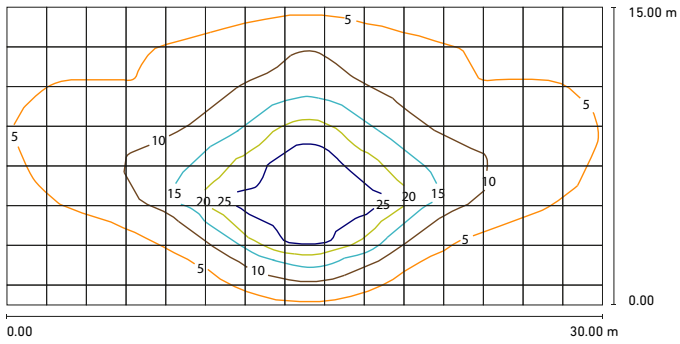

Ancho de Calle:	7 m
Altura de Montaje:	8 m
Distancia Interpostal:	40 m
E max.	21 lx
E prom.	9 lx
E min.	2 lx
Uniformidad:	4.5

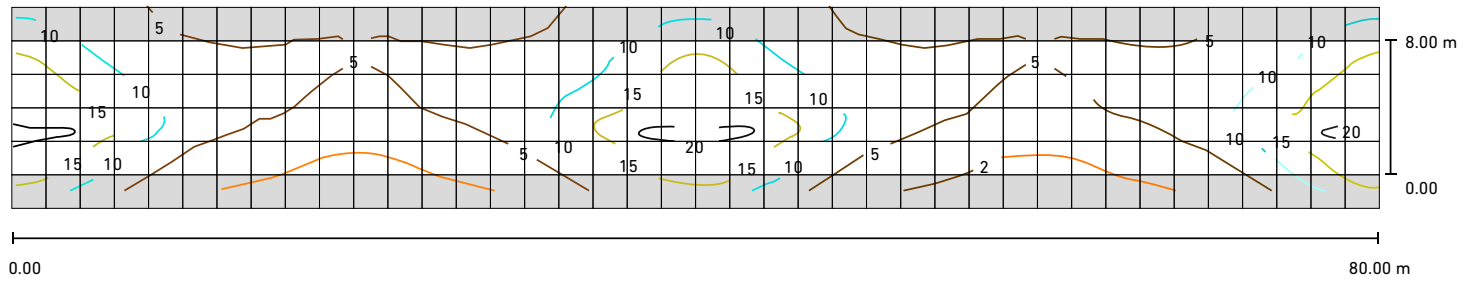

NOTA

EJEMPLO DE REFERENCIA.

La disposición de calle está basada en el protocolo de pruebas PAESE Anexo 1, Croquis B para vías Secundarias, cumpliendo con los valores establecidos en la tabla X

CITI 100

CLAVE	W	V~	FP	Hz	THD	TEMP. DE COLOR	lm	lm/W	IRC	ÓPTICA	COLOR	PESO	IP
L7503-6H0	105	100-240	>0.9	50/60	13%	5000K	10,500	105	≥73	Tipo III M	■	4,440 gr	IP 65

Opcional

L7599-6H0	105	100-305	>0.9	50/60	13%	5000K	10,500	105	≥73	Tipo III M	■	4,440 gr	IP 65
-----------	-----	---------	------	-------	-----	-------	--------	-----	-----	------------	---	----------	-------

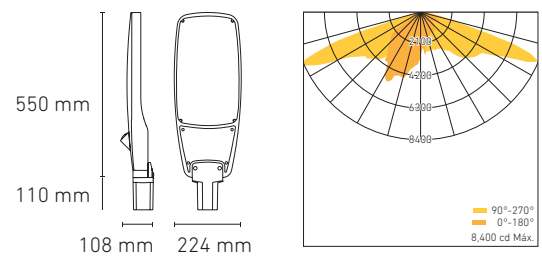

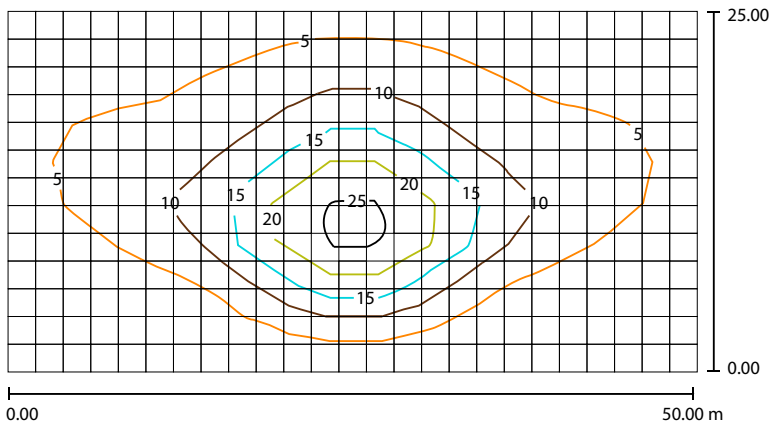

Ancho de Calle: 12 m
 Altura de Montaje: 9 m
 Distancia Interpostal: 30 m
 E max. 33 lx
 E prom. 17 lx
 E min. 8 lx
 Uniformidad: 2.1

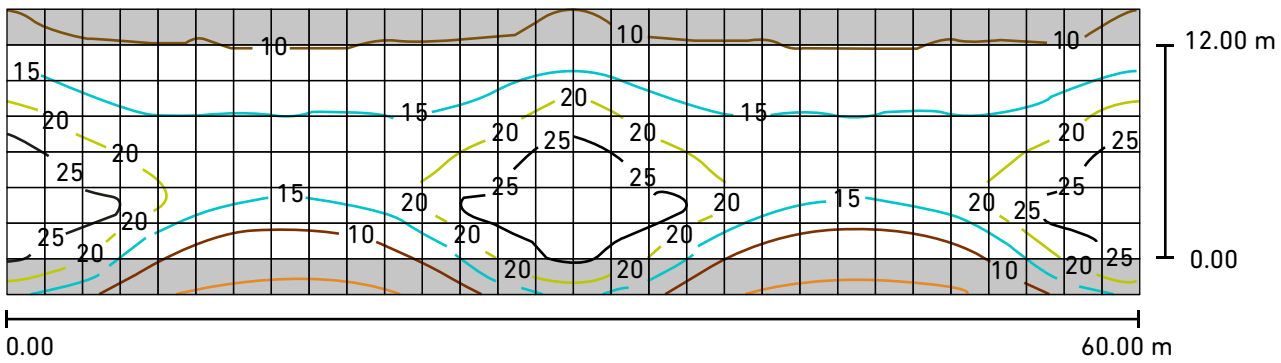

NOTA

EJEMPLO DE REFERENCIA.

La disposición de calle está basada en el protocolo de pruebas PAESE Anexo 1, Croquis A para vías Principales, cumpliendo con los valores establecidos en la tabla X

FLUORESCENTES

En MAGG nos preocupamos por satisfacer la demanda de luminarias de cualquier tecnología, por lo tanto ponemos a su disposición nuestro catálogo de luminarias para lámparas fluorescentes, contamos para aplicaciones de exterior e interior.

Categoría: INTERIORES

Familia: **SERIE DECO**

STAR

MODELO	CLAVE	COLOR	PESO	IP
STAR	L1001-B00	■	-	IP 50
	L1001-800	■		
STAR V3	L1010-B00	■	1,058 gr	
	L1010-800	■		

Lámpara GU10 NO Incluida.

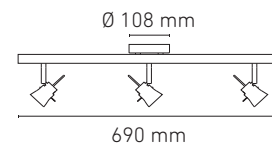
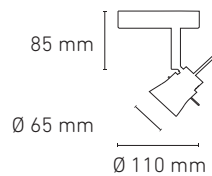

DRESS

MODELO	CLAVE	COLOR	PESO	IP
DRESS	L1002-B00	■	-	IP 50
	L1002-800	■		
DRESS V3	L1011-B0	■	823 gr	
	L1011-800	■		

Lámpara GU10 NO Incluida.

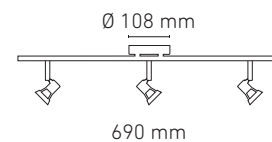
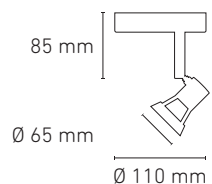

STONE

MODELO	CLAVE	COLOR	PESO	IP
STONE	L1003-B00	■	-	IP 50
	L1003-800	■		
STONE V3	L1012-B00	■	888 gr	
	L1012-800	■		

Lámpara GU10 NO Incluida.

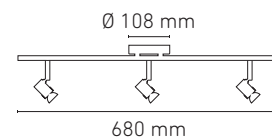
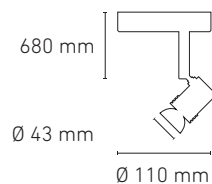

REED

MODELO	CLAVE	COLOR	PESO	IP
REED	L1004-B00	■	-	IP 50
REED V3	L1013-B00		788 gr	

Lámpara GU10 NO Incluida.

REED

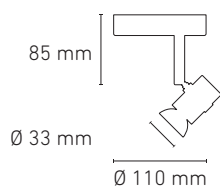

REED V3

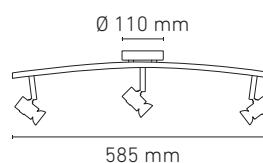

ROCK

MODELO	CLAVE	COLOR	PESO	IP
ROCK	L1006-B00	■	-	IP 50
ROCK P3	L1030-B00		924 gr	
ROCK V3	L1015-B00		908 gr	

Lámpara GU10 NO Incluida.

ROCK

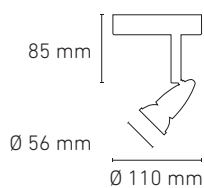

ROCK P3

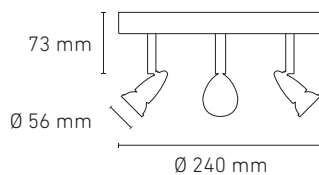

ROCK V3

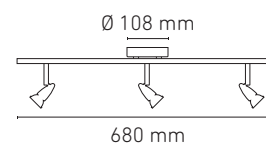

ACE

MODELO	CLAVE	COLOR	PESO	IP
ACE	L1005-B00	■	370 gr	IP 50
	L1005-800	■		
ACE P3	L1031-B00	■	1,135 gr	
	L1031-800	■		
ACE V3	L1014-B00	■	1,124 gr	
	L1014-800	■		
ACE V4	L1020-B00	■	1,420gr	
	L1020-800	■		

Lámpara GU10 NO Incluida.

ACE



ACE P3



ACE V3

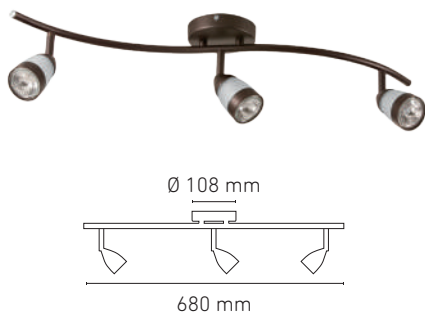

ACE V4

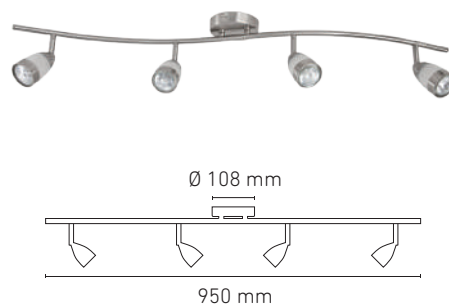

DUET

MODELO	CLAVE	COLOR	IP
DUET CL2	L1040-B00	■	IP 50

Lámpara GU10 NO Incluida.

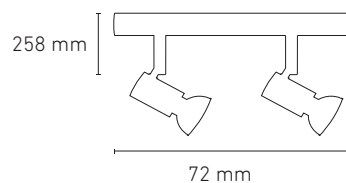

SUSPENDIDOS

GLOBE

MODELO	CLAVE	W	COLOR	IP50
GLOBE 6"	L1401-100	25	□	900 gr.
GLOBE 6"	L1401-B00		■	
GLOBE 8"	L1402-100	60	□	1,050 gr.
GLOBE 8"	L4102-B00		■	
GLOBE 10"	L1403-100	75	□	1,290 gr.
GLOBE 10"	L1403-B00		■	
GLOBE 12"	L1404-100	75	□	1,465 gr.
GLOBE 12"	L1404-B00		■	
GLOBE 14"	L1405-100	100	□	1,918 gr.
GLOBE 14"	L1405-B00		■	
GLOBE 16"	L1406-100	100	□	4,700 gr.
GLOBE 16"	L1406-B00		■	

Altura 2000 mm Máx.
E26No incluida.



6"

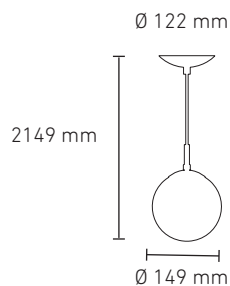

8"

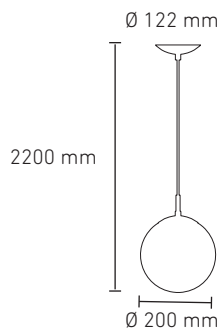

10"

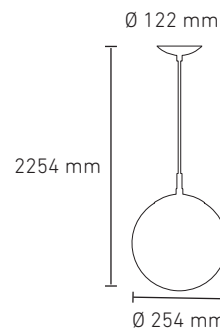

12"

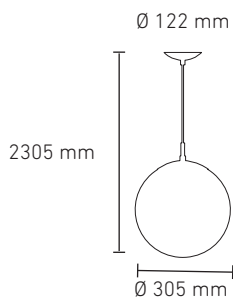

14"

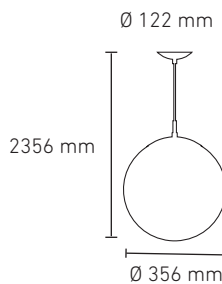

16"

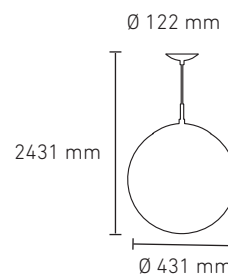

FAROLES

MÉRIDA

CLAVE	MODELO	W	V-	Hz	COLOR	PESO						
L1601-100	Soportado	40	90-140	60	□	820 gr						
L1601-300					■							
L1601-800					■							
L1602-100	Suspendido				40	90-140	60	□	970 gr			
L1602-300								■				
L1602-800								■				
L1603-100	Colgante							40	90-140	60	□	955 gr
L1603-300											■	
L1603-800											■	

Lámpara no incluida. Base E26

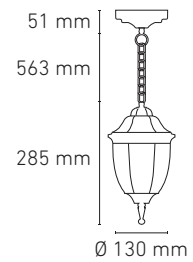
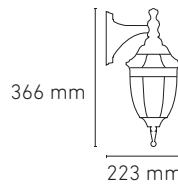
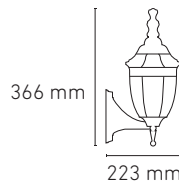

SAN MIGUEL

CLAVE	MODELO	W	V-	Hz	COLOR	PESO						
L1610-300	Soportado	20	90-140	60	■	1,700 gr						
L1610-800					■							
L1611-300	Suspendido				20	90-140	60	■	1,400 gr			
L1611-800								■				
L1612-300	Colgante							20	90-140	60	■	1,700 gr
L1612-800											■	

Lámpara no incluida. Base E26

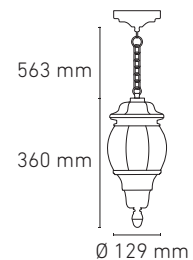
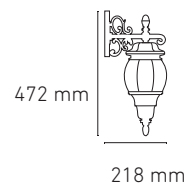

EMPOTRADOS DIRIGIBLES

ISIS

MODELO	CLAVE	W	V-	FP	Hz	COLOR	PESO
ISIS I	L1740-1E0	1x50				□	1,130 gr
	L1740-3E0					■	
	L1740-5E0					■	
ISIS II	L1741-1E0	2x50	90-140	>0.98	50/60	□	1,430 gr
	L1741-3E0					■	
	L1741-5E0					■	
ISIS III	L1742-1E0	3x50				□	1,730 gr
	L1742-3E0					■	
	L1742-5E0					■	

Lámpara no incluida.



20°

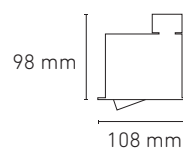

20°

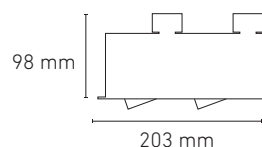

20°

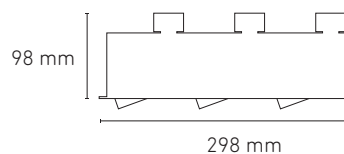

ISIS PIN HOLE

MODELO	CLAVE	W	V-	FP	Hz	COLOR	PESO
PIN I	L1743-1E0	1x50	90-140	>0.98	50/60	□	1,035 gr
	L1743-5E0					■	
PIN II	L1744-1E0	2x50				□	1,440 gr

Lámpara no incluida.

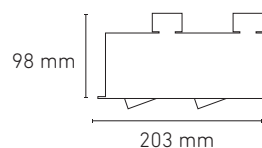
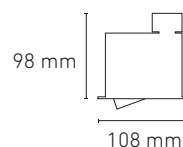

SOYUZ

MODELO	CLAVE	W	COLOR
PRO	L1760-100	50	□
ø95mm	L1764-100		
ø122mm	L1765-100		

Lámpara no incluida.

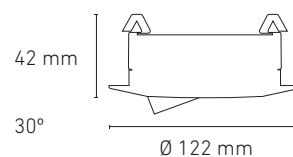
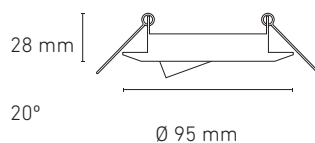
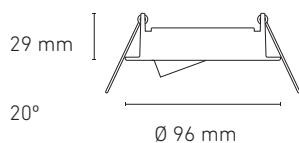

PIN HOLE DIRIGIBLE

MODELO	CLAVE	W	COLOR
DIRIGIBLE	L1761-100	50	□
	L1761-300		■

Lámpara no incluida.

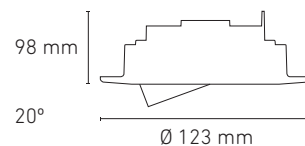

LIVING

MODELO	CLAVE	W	COLOR
LIVING	L1766-100	50	□

Lámpara no incluida.

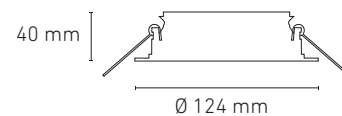

EMPOTRADOS FIJOS

ORIÓN

MODELO	CLAVE	W	COLOR
PRO	L1750-100	50	□
CIRCULAR	L1751-100		

Lámpara no incluida.
Transformador no incluido.



ORIÓN PRO

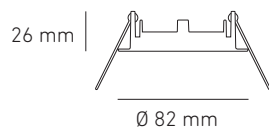

ORIÓN CIRCULAR

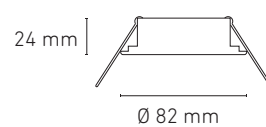

LINEALES / SOBREPONER

BL

MODELO	CLAVE	W	V-	FP	Hz	TEMP. DE COLOR	lm	COLOR
24	L2180-1F0	24	90-140	0.5	50/60	4100K	1670	□
	L2180-1G0					6500K		
39	L2181-1F0	39				4100K	3050	
	L2181-1G0					6500K		
54	L2182-1F0	54				4100K	4220	
	L2182-1G0					6500K		
32	L2185-1F0	32	4100K	2200				
	L2185-1G0		6500K					



Lámpara incluida

IP62

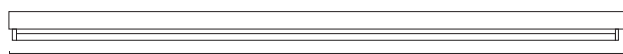

1185 mm

LÁMPARAS LINEALES T5 / T8

MODELO	CLAVE	W	BASE	TEMP. DE COLOR	lm	IRC	DIMENSIONES
T5	F9216-000	8	G5	3500K	440	82	302x16 mm
	F9217-000			4100K			
	F9218-000			6500K			
	F9206-000	14		3500K	1200		560x16 mm
	F9141-000			4100K			
	F9201-000			6500K			
	F9207-000	21		3500K	2000		860x16 mm
	F9142-000			4100K			
	F9202-000			6500K			
	F9106-000	24		4100K	1700		560x16 mm
	F9211-000			6500K			
	F9208-000			3500K			
F9143-000	4100K						
F9203-000	6500K						
T8	F9103-000	32	G13	4100K	2750	82	1212x25 mm
	F9200-000			6500K			
T5	F9144-000	35	G5	4100K	3200		1462x16 mm
	F9204-000			6500K			
	F9210-000	54		3500K	4875		1162x16 mm
	F9145-000			4100K			
	F9205-000			6500K			
F9110-000	80	6075					



OFFICE

KROMOS II

MODELO	CLAVE	W	V-	FP	Hz	TEMP. DE COLOR	lm	COLOR	PESO	IP
3x14W EMPONTRAR	L2310-2F0	3x14	90-140	0.5	50/60	4100K	2300	□	3,300 gr	IP 40
	L2310-2G0					6500K				
3x28W EMPOTRAR	L2312-2F0	3x28	100-305	0.98	50/60	4100K	4400		6,050 gr	
	L2312-2G0					6500K				
3x14W SOBREPONER	L2311-2F0	3x14	90-140	0.5	50/60	4100K	2300		4,500 gr	
	L2311-2G0					6500K				

Lámpara incluida



KROMOS II 3X14W EMPOTRAR

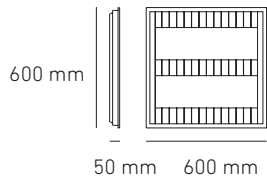

KROMOS II 3X14W SOBREPONER

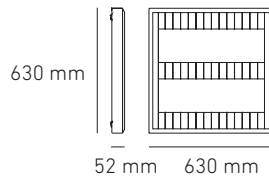

KROMOS II 3X28W EMPOTRAR

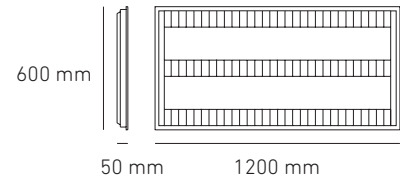

SUBURBANO

KITE

MODELO	CLAVE	W	V-	FP	Hz	TEMP. DE COLOR	COLOR	PESO	IP
FOTOCELDA	L2211-1G0	13	90-140	0.5	50/60	6500K	□	650 gr	IP 65
	L2211-3G0						■		
SIN FOTOCELDA	L2210-1G0	13	90-140	0.5	50/60	6500K	□		
	L2210-3G0						■		

Lámpara incluida

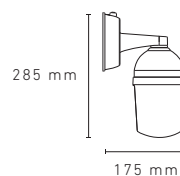

LINEALES IP

T5

MODELO	CLAVE	W	V-	FP	Hz	TEMP. DE COLOR	lm	lm/W	IRC	PANTALLA	PESO	IP
1x54W	L2603-5F0	1x54	90-140	0.5	50/60	4100K	3960	74	≥80	Transparente	1,895 gr	IP 65
	L2603-5G0					6500K						
2x28W	L2601-5F0	2x28	90-140	0.5		4100K	4200	75			2,530 gr	
	L2601-5G0					6500K						
2x54W	L2608-5G0	2x54	100-305	0.98		4100K	5800	54				
	L2608-5F0											

Lámpara incluida



T8

MODELO	CLAVE	W	V-	FP	Hz	TEMP. DE COLOR	lm	lm/W	IRC	PANTALLA	PESO	IP
1x32W	L2605-5F0	1x32	90-140	0.5	50/60	4100K	2200	60	≥80	Transparente	1,850 gr	IP 65
	L2605-5G0					6500K						
2x32W	L2606-5F0	2x32	90-140	0.95		4100K	4400	69			2,520 gr	
	L2607-5G0			0.5		6500K						

Lámpara incluida

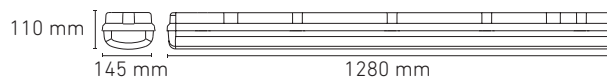

BALASTROS

BALASTROS T8

LÁMPARAS	CLAVE	W	V-	FP	ENCENDIDO	a	b	c	x	y	ø	CONEXIÓN	DIMENSIONES (mm)	
2	B0437-100	17	90-140	0.98	Instantáneo	230	30	28	221	20	5	C04	D02	
	B0437-100	25												
1	B0449-100	32		0.5	Rápido	168	26	19	157	-	4.2	C01	D01	
B0534-100	210					28	22	202	-	C11				
2	B0434-100			0.98	Instantáneo	177	30	28	167	221	20	5	C04	D02
	B0437-100					230			-					
3	B0436-000	100-305		0.98	Rápido	268	44	35	258	-	5	C14	D02	

CONEXIONADO



C01



C04

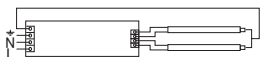

C11



C14

DIMENSIONES

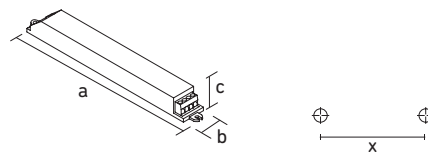

D01

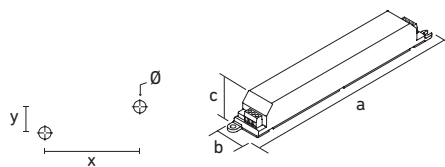

D02

BALASTROS T5

LÁMPARAS	CLAVE	W	V~	FP	ENCENDIDO	a	b	c	x	y	ø	CONEXIÓN	DIMENSIONES (mm)
1	B0404-100	14	90-140	0.5	Rápido	168	26	19	157	-	4.2	C01	D01
3	B0386-100				Instantáneo	70	102	32	60	93	5	C03	D07
	B0394-000		100-305	0.98	125	63	31	118	-	4	D04		
1	B0405-100	21	90-140	0.5	Rápido	168	26	19	157	-	4.2	C01	D01
2	B0389-000	24			Instantáneo	205	29	27	195	19	5	C04	D02
1	B0406-100	28			Rápido	168	26	19	157	-	4.2	C01	D01
2	B0408-100				Instantáneo	210	28	22	202	-	5	C11	
3	B0416-000	28	90-140	0.98	Instantáneo	149	80	39	139	70	4	C12	D03
	B0413-000		100-305		Instantáneo	268	44	35	258	33	5	C09	D02
1	B0571-000	39	90-140	0.5	Rápido	168	26	19	157	-	4.2	C01	D01
	B0379-100	54				210	28	22	202	-	5		
2	B0430-000	54	100-305	0.98	Rápido	302	32	30	293	-	5	C16	D02

CONEXIONADO

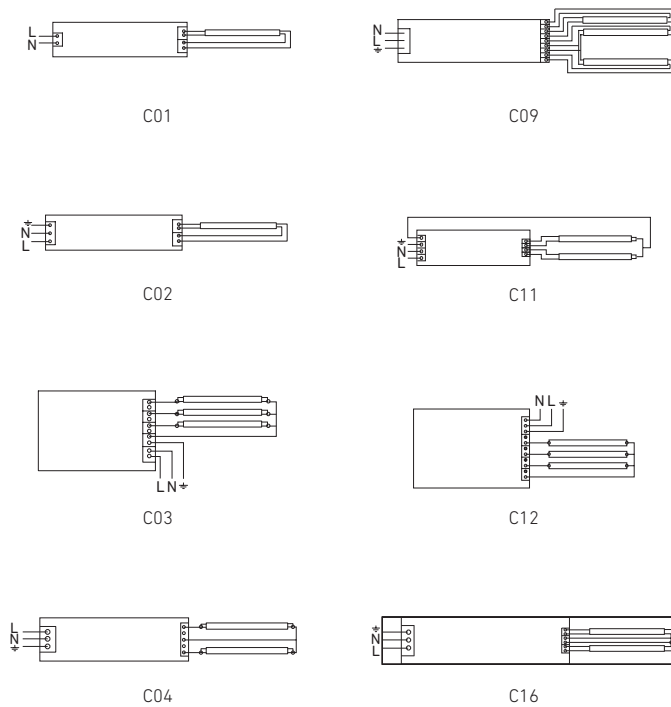

DIMENSIONES

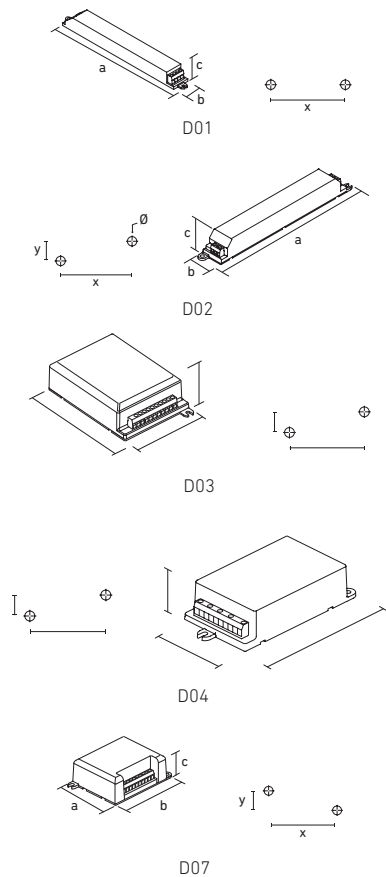

BALASTROS FLUORESCENTES COMPACTOS

LÁMPARAS	CLAVE	W	V~	FP	ENCENDIDO	a	b	c	x	y	∅	CONEXIÓN	DIMENSIONES (mm)
1	B0494-000	13	90-140	0.5	Rápido	92	50	26	-	-	-	C17	D08
	93					61	30	-	-	-	C18	D09	
	63					44		-	-	-	D11		
2	B0419-000	26	100-305	0.98	Instantáneo	120	37	32	112	-	4	C19	D10
1	B0362-000					91	57		81	44	3.4	C23	D11
2	B0390-100	32	100-305	0.98	Rápido	125	63	30	118	-	4	C24	D04
	B0392-000					-	-		C06	D06			
	B0411-100					-	-						
1	B0392-000	42											
2	B0411-100												



CONEXIONADO

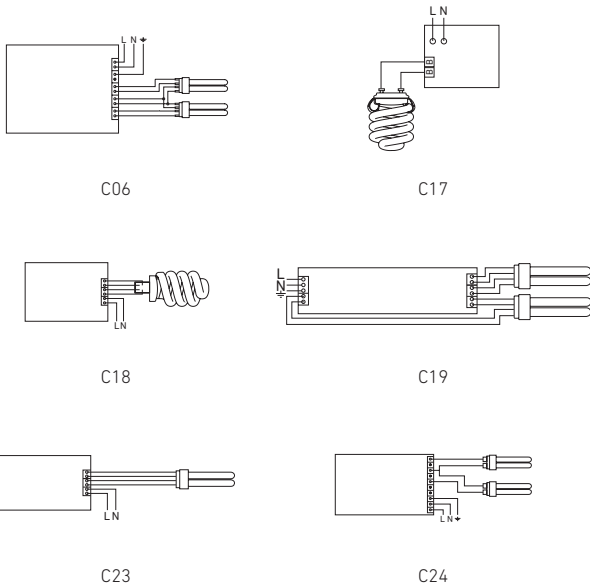

DIMENSIONES

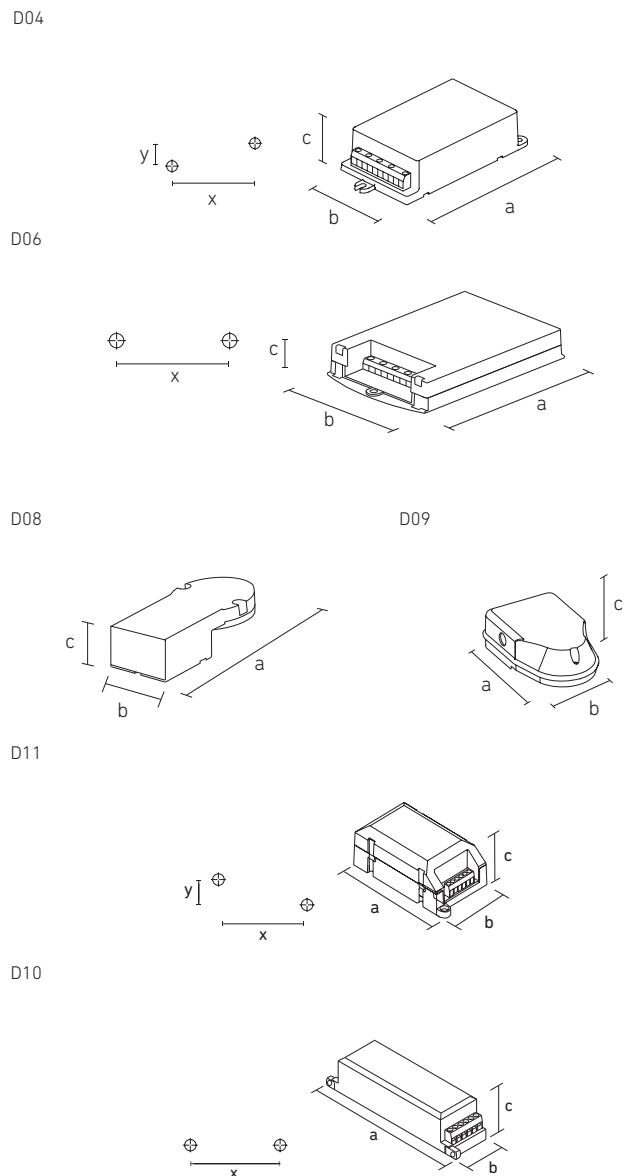

BALASTRO CIRCULAR T5

LÁMPARAS	CLAVE	W	V~	FP	ENCENDIDO	a	b	c	x	y	ø	CONEXIÓN	DIMENSIONES (mm)
1	B0171-100	18	90-140	0.5	Rápido	93	47	32	85	38	3	C05	D013
	B0172-100	26											D013
	B0173-100	34											D013

TRANSFORMADORES

127-12V

CAPACIDAD EN VA	CLAVE	a	b	c	x	y	PESO	DIMENSIONES (mm)
6	A2537-000	34	44	23	-	-	0.16	D30
50	A1382-200	58	57	48	-	-	0.72	D28
	A1474-100				-	-	0.68	
100	A0239-200	86	79	75	70	61	1.8	D27
200	A1374-100	105	77	104	75	61	2.5	D29
300	A1375-100		92	104	74	75	3.3	
500	A0784-000		115	111	112	85	95	

NOMENCLATURA

T/A: TEMPERATURA AMBIENTE
 A/T: ALTA TEMPERATURA
 S/B: SIN BASE

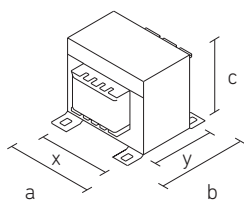

D27

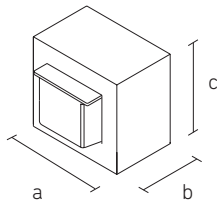

D28

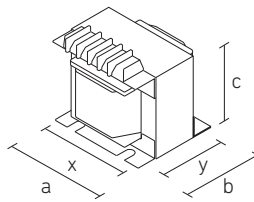

D29

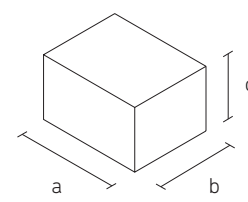

D30

USO GENERAL

CLAVE	W	VOLTAJE DE ALIMENTACIÓN (IN)	VOLTAJE DE SALIDA (OUT)	COLOR
B0174-200	50	127V~± 10%	12V	□

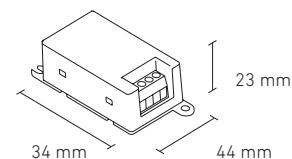

MINIMAGG ENCAPSULADO

CLAVE	W	VOLTAJE DE ALIMENTACIÓN (IN)	VOLTAJE DE SALIDA (OUT)	COLOR
B0191-000	50	127V~± 10%	12V	■

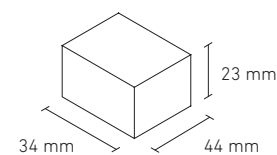

USO GENERAL ENCAPSULADO

CLAVE	W	VOLTAJE DE ALIMENTACIÓN (IN)	VOLTAJE DE SALIDA (OUT)	COLOR
B0531-000	50	277V~± 10%	12V	■

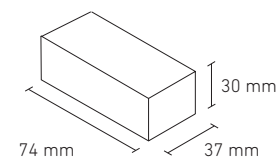

ACCESORIOS

LOW VOLTAGE RIELES

DESCRIPCIÓN	CLAVE	COLOR
RIEL 0,50 m 127 V	R1001-000	
RIEL 0,60 m 127 V	R1002-000	□
RIEL 1,00 m 127 V	R1003-000	
RIEL 1,00 m 127 V	R1003-100	■
RIEL 1,20 m 127 V	R1004-000	□
RIEL 1,20 m 127 V	R1004-100	■
RIEL 2,00 m 127 V	R1005-000	□
RIEL 2,00 m 127 V	R1005-100	■
RIEL 2,40 m 127 V	R1006-000	□
RIEL 2,40 m 127 V	R1006-100	■



SOCKET

DESCRIPCIÓN	CLAVE
SOCKET PARA LÁMPARA DICROICA MR11 / MR16	B0053-000
SOCKET PARA LÁMPARA GU10	P0217-000



FOTOCONTROL COMPACTO EMPOTRABLE ELECTRÓNICO

VOLTAJE DE ALIMENTACIÓN (IN)	CLAVE	CARGA MÁXIMA
127V~±10%	P0175-000	300W INCANDESCENTE



CONECTORES

CONECTOR	CLAVE	
T	P0058-000	- IP68
I	P0059-000	



CLAVES

CLAVE	PÁGINA	CLAVE	PÁGINA	CLAVE	PÁGINA	CLAVE	PÁGINA	CLAVE	PÁGINA
A									
A0239-200	229	B0434-100	226	F5147-030	173	L1005-B00	218	L1610-300	220
A0784-000	229	B0436-000	226	F5147-010	173	L1006-B00	217	L1610-800	220
A1374-100	229	B0437-100	226	F5152-030	173	L1010-800	214	L1611-300	220
A1375-100	229	B0437-100	226	F5152-010	173	L1010-B00	214	L1611-800	220
A1382-200	229	B0437-100	226	F5158-030	174	L1011-800	214	L1612-300	220
A1474-100	229	B0449-100	226	F5158-010	174	L1011-B00	214	L1612-800	220
A2537-000	229	B0494-000	228	F5159-030	174	L1012-800	214	L1733-100	63
		B0531-000	229	F5159-010	174	L1012-B00	214	L1733-300	63
B									
B0053-000	230	B0534-100	226	F9103-000	223	L1013-B00	217	L1740-1E0	221
B0109-000	226	B0559-000	227	F9106-000	223	L1014-800	218	L1740-3E0	221
B0171-100	229	B0571-000	227	F9110-000	223	L1014-B00	216	L1740-5E0	221
B0172-100	229			F9141-000	223	L1015-B00	217	L1741-1E0	221
B0173-100	229	F		F9142-000	223	L1020-800	216	L1741-3E0	221
B0174-200	229	F5040-1E3	172	F9143-000	223	L1020-B00	216	L1741-5E0	221
B0191-000	229	F5040-1E9	172	F9144-000	223	L1030-B00	217	L1742-1E0	221
B0362-000	228	F5040-1I3	172	F9145-000	223	L1031-800	216	L1742-3E0	221
B0379-100	227	F5040-1I9	172	F9200-000	223	L1031-B00	216	L1742-5E0	221
B0379-200	225	F5040-3E3	172	F9201-000	223	L1040-B00	216	L1743-1E0	221
B0386-100	227	F5040-3E9	172	F9202-000	223	L1401-100	219	L1743-5E0	221
B0389-000	227	F5040-3I3	172	F9203-000	223	L1401-B00	219	L1744-1E0	221
B0390-100	228	F5040-3I9	172	F9204-000	223	L1402-100	219	L1750-100	222
B0392-000	228	F5041-1E3	172	F9205-000	223	L1402-B00	219	L1751-100	222
B0392-000	228	F5041-1E9	172	F9206-000	223	L1403-100	219	L1760-100	222
B0392-000	228	F5041-1I3	172	F9207-000	223	L1403-B00	219	L1761-100	222
B0394-000	227	F5041-1I9	172	F9208-000	223	L1404-100	219	L1761-300	222
B0396-000	224	F5041-3E3	172	F9210-000	223	L1404-B00	219	L1764-100	222
B0396-000	225	F5041-3E9	172	F9211-000	223	L1405-100	219	L1765-100	222
B0398-100	225	F5041-3I3	172	F9216-000	223	L1405-B00	219	L1766-100	222
B0404-100	227	F5041-3I9	172	F9217-000	223	L1406-100	219	L1832-100	80
B0405-100	227	F5045-030	173	F9218-000	223	L1406-B00	219	L1832-300	80
B0406-100	227	F5045-010	173			L1601-100	220	L1842-100	80
B0407-100	225	F5056-030	173	L		L1601-300	220	L1842-300	80
B0408-100	227	F5056-010	173	L1001-800	218	L1601-800	220	L2180-1F0	223
B0411-100	228	F5141-030	173	L1001-B00	218	L1602-100	220	L2180-1G0	223
B0411-100	228	F5141-0E0	173	L1002-800	218	L1602-300	220	L2181-1F0	223
B0413-000	227	F5141-010	173	L1002-B00	218	L1602-800	220	L2181-1G0	223
B0416-000	227	F5142-030	173	L1003-800	218	L1603-100	220	L2182-1F0	223
B0419-000	228	F5142-010	173	L1003-B00	218	L1603-300	220	L2182-1G0	223
B0427-000	228	F5146-030	173	L1004-B00	217	L1603-800	220	L2183-1F0	220
B0430-000	227	F5146-010	173	L1005-800	218				

CLAVE	PÁGINA	CLAVE	PÁGINA	CLAVE	PÁGINA	CLAVE	PÁGINA	CLAVE	PÁGINA
L2183-1G0	220	L5006-1I0	23	L5071-130	20	L5177-YEJ	57	L5270-130	159
L2184-1F0	220	L5008-130	21	L5071-1E0	20	L5201-130	156	L5270-1E0	159
L2184-EF0	220	L5008-1E0	21	L5071-1I0	20	L5201-1E0	156	L5275-130	159
L2185-1F0	223	L5008-1I0	21	L5071-B30	20	L5213-130	152	L5275-1E0	159
L2185-1G0	223	L5015-1E6	39	L5071-BE0	20	L5213-1E0	152	L5333-130	118
L2186-1F0	220	L5015-1E9	39	L5071-BI0	20	L5213-830	152	L5333-1I0	118
L2201-6G0	221	L5015-1ED	39	L5072-130	21	L5213-8E0	152	L5335-630	119
L2202-6G0	221	L5015-1I6	39	L5072-1E0	21	L5235-130	152	L5335-6I0	119
L2204-6G0	221	L5015-1I9	39	L5072-1I0	21	L5235-1E0	152	L5343-130	118
L2210-1G0	224	L5015-1ID	39	L5073-130	21	L5235-830	152	L5343-1I0	118
L2210-3G0	224	L5015-BED	39	L5073-1E0	21	L5235-8E0	152	L5401-530	104
L2211-1G0	224	L5015-BID	39	L5073-1I0	21	L5236-130	152	L5401-5I0	104
L2211-3G0	224	L5024-1E6	40	L5074-130	20	L5236-1E0	152	L5405-530	104
L2310-2F0	224	L5024-1E9	40	L5074-1E0	20	L5236-830	152	L5405-5I0	104
L2310-2G0	224	L5024-1ED	40	L5074-1I0	20	L5236-8E0	152	L5406-530	108
L2311-2F0	224	L5024-1I6	40	L5074-BI0	20	L5241-130	153	L5409-530	104
L2311-2G0	224	L5024-1I9	40	L5143-EE5	58	L5241-1E0	153	L5409-5I0	104
L2312-2F0	224	L5024-1ID	40	L5143-EI5	58	L5241-830	153	L5411-530	103
L2312-2G0	224	L5024-BE9	40	L5144-EE5	58	L5241-8E0	153	L5411-5I0	103
L2601-5F0	225	L5024-BED	40	L5144-EI5	58	L5242-130	153	L5413-530	105
L2601-5G0	225	L5024-BI9	40	L5145-EE5	58	L5242-1E0	153	L5413-5I0	105
L2602-5F0	225	L5024-BID	40	L5145-EI5	58	L5242-830	153	L5417-530	104
L2603-5F0	225	L5032-1E6	41	L5150-3I9	148	L5242-8E0	153	L5417-5I0	104
L2603-5G0	225	L5032-1E9	41	L5150-EI9	148	L5243-130	153	L5418-530	104
L2605-5F0	225	L5032-1ED	41	L5151-3I9	148	L5243-1E0	153	L5418-530	108
L2605-5G0	225	L5032-1I6	41	L5151-EI9	148	L5243-830	153	L5418-5I0	104
L2606-5F0	225	L5032-1I9	41	L5152-3I9	149	L5243-8E0	153	L5418-5I0	108
L2607-5F0	225	L5032-1ID	41	L5152-EI9	149	L5245-130	157	L5421-530	106
L2607-5G0	223	L5040-1E6	42	L5153-3I9	149	L5245-1E0	157	L5421-5I0	106
L2608-5F0	225	L5040-1E9	42	L5153-EI9	149	L5245-830	157	L5423-530	106
L2608-5G0	225	L5040-1ED	42	L5175-1E4	56	L5245-8E0	157	L5423-5I0	106
L5003-1E9	38	L5040-1I6	42	L5175-1EJ	56	L5250-130	156	L5442-530	107
L5003-1ED	38	L5040-1I9	42	L5175-YE4	56	L5250-1E0	156	L5442-5I0	107
L5003-1I9	38	L5040-1ID	42	L5175-YEJ	56	L5255-130	158	L5446-530	109
L5003-1ID	38	L5050-1E5	43	L5176-1E4	57	L5255-1E0	158	L5446-5I0	109
L5003-BED	38	L5050-1I5	43	L5176-1EJ	57	L5260-130	158	L5457-530	109
L5003-BID	38	L5050-1ID	43	L5176-YE4	57	L5260-1E0	158	L5457-5I0	109
L5004-1I0	23	L5060-1E5	78	L5176-YEJ	57	L5265-130	157	L5463-530	107
L5005-130	23	L5060-1EA	78	L5177-1E4	57	L5265-1E0	157	L5463-5I0	107
L5005-1I0	23	L5060-1I5	78	L5177-1EJ	57	L5265-830	157	L5479-530	103
L5006-130	23	L5060-1IA	78	L5177-YE4	57	L5265-8E0	157	L5479-5I0	103

CLAVE	PÁGINA	CLAVE	PÁGINA	CLAVE	PÁGINA	CLAVE	PÁGINA	CLAVE	PÁGINA
L5489-530	103	L5645-300	79	L5667-3E5	71	L5810-630	114	L5902-100	63
L5489-510	103	L5646-1E3	98	L5667-3E9	71	L5810-6E0	114	L5902-300	63
L5511-130	84	L5646-1E9	98	L5667-3I5	71	L5810-6I0	114	L5903-100	63
L5511-110	84	L5646-1I3	98	L5667-3I9	71	L5815-630	114	L5903-300	63
L5512-130	84	L5646-1I9	98	L5668-1E5	70	L5815-6E0	114	L5904-100	63
L5512-110	84	L5660-1E5	75	L5668-1E9	70	L5815-6I0	114	L5904-300	63
L5520-130	88	L5660-1E9	75	L5668-1I5	70	L5817-630	115	L5905-YEK	48
L5520-1E0	88	L5660-1I5	75	L5668-1I9	70	L5817-6E0	115	L5905-YEL	48
L5520-110	88	L5660-1I9	75	L5668-3E5	70	L5817-6I0	115	L5905-YIK	48
L5521-130	88	L5660-3E5	75	L5668-3E9	70	L5820-100	64	L5905-YIL	48
L5521-1E0	88	L5660-3E9	75	L5668-3I5	70	L5820-300	64	L5906-YEK	49
L5521-110	88	L5660-3I5	75	L5668-3I9	70	L5821-100	64	L5906-YEL	49
L5523-130	88	L5660-3I9	75	L5670-1E5	72	L5821-300	64	L5906-YIK	49
L5523-1E0	88	L5661-1E5	75	L5670-1E9	72	L5822-100	64	L5906-YIL	49
L5523-110	88	L5661-1E9	75	L5670-1I5	72	L5822-300	64	L5907-YEK	49
L5526-130	89	L5661-1I5	75	L5670-1I9	72	L5823-100	64	L5907-YEL	49
L5526-1E0	89	L5661-1I9	75	L5670-3E5	72	L5823-300	64	L5907-YIK	49
L5526-110	89	L5661-3E5	75	L5670-3E9	72	L5830-1E0	97	L5907-YIL	49
L5554-130	85	L5661-3E9	75	L5670-3I5	72	L5830-1I0	97	L5908-YEK	50
L5554-110	85	L5661-3I5	75	L5670-3I9	72	L5830-3E0	97	L5908-YEL	50
L5555-130	85	L5661-3I9	75	L5671-1E5	73	L5830-3I0	97	L5908-YIK	50
L5555-110	85	L5662-1E5	74	L5671-1E9	73	L5831-1E0	97	L5908-YIL	50
L5571-130	87	L5662-1E9	74	L5671-1I5	73	L5831-1I0	97	L5909-YEK	51
L5571-110	87	L5662-1I5	74	L5671-1I9	73	L5831-3E0	97	L5909-YEL	51
L5592-130	87	L5662-1I9	74	L5671-3E5	73	L5831-3I0	97	L5909-YIK	51
L5592-110	87	L5662-3E5	74	L5671-3E9	73	L5833-1E0	97	L5909-YIL	51
L5640-1E3	98	L5662-3E9	74	L5671-3I5	73	L5833-1I0	97	L5910-YEK	51
L5640-1E9	98	L5662-3I5	74	L5671-3I9	73	L5833-3E0	97	L5910-YEL	51
L5640-1I3	98	L5662-3I9	74	L5672-1E5	73	L5833-3I0	97	L5910-YIK	51
L5640-1I9	98	L5666-1E5	71	L5672-1E9	73	L5841-330	122	L5910-YIL	51
L5641-100	79	L5666-1E9	71	L5672-1I5	73	L5842-330	122	L5911-YEK	52
L5641-1E3	98	L5666-1I5	71	L5672-1I9	73	L5874-330	122	L5911-YEL	52
L5641-1E9	98	L5666-1I9	71	L5672-3E5	73	L5875-330	123	L5911-YIK	52
L5641-1I3	98	L5666-3E5	71	L5672-3E9	73	L5885-330	122	L5911-YIL	52
L5641-1I9	98	L5666-3E9	71	L5672-3I5	73	L5886-330	122	L5912-YEK	53
L5641-300	79	L5666-3I5	71	L5672-3I9	73	L5888-330	122	L5912-YEL	53
L5645-100	79	L5666-3I9	71	L5701-530	105	L5889-330	122	L5912-YIK	53
L5645-1E3	98	L5667-1E5	71	L5701-5I0	105	L5891-330	122	L5912-YIL	53
L5645-1E9	98	L5667-1E9	71	L5806-630	115	L5892-330	122	L5913-YEK	53
L5645-1I3	98	L5667-1I5	71	L5806-6E0	115	L5901-100	63	L5913-YEL	53
L5645-1I9	98	L5667-1I9	71	L5806-6I0	115	L5901-300	63	L5913-YIK	53

CLAVE	PÁGINA	CLAVE	PÁGINA	CLAVE	PÁGINA	CLAVE	PÁGINA	CLAVE	PÁGINA
L5913-YIL	53	L6055-130	89	L6332-130	34	L6359-130	25	L6375-110	31
L5914-YE4	46	L6055-1E0	89	L6332-110	34	L6359-130	30	L6376-130	31
L5914-YEJ	46	L6055-110	89	L6335-130	26	L6359-1E0	25	L6630-130	35
L5914-YI4	46	L6082-130	86	L6335-130	31	L6359-1E0	30	L6376-110	31
L5914-YIJ	46	L6082-110	86	L6335-1E0	26	L6359-110	25	L6630-110	35
L5914-ZEJ	46	L6083-130	86	L6335-1E0	31	L6359-110	30	L6377-130	30
L5914-ZIJ	46	L6083-110	86	L6335-110	26	L6360-130	28	L6377-110	30
L5915-YE4	47	L6101-830	12	L6335-110	31	L6360-1E0	28	L6383-130	33
L5915-YEJ	47	L6101-8E0	12	L6340-130	26	L6361-130	28	L6383-110	33
L5915-YI4	47	L6102-830	12	L6340-130	31	L6361-1E0	28	L6384-130	34
L5915-YIJ	47	L6102-8E0	12	L6340-1E0	26	L6362-130	28	L6384-110	34
L5915-ZEJ	47	L6103-830	12	L6340-1E0	31	L6362-1E0	28	L6391-130	22
L5915-ZIJ	47	L6103-8E0	12	L6340-110	26	L6362-110	28	L6391-1E0	22
L5916-YE4	47	L6104-830	12	L6340-110	31	L6363-130	29	L6391-110	22
L5916-YEJ	47	L6104-8E0	12	L6341-130	26	L6363-1E0	29	L6395-130	21
L5916-YI4	47	L6105-830	12	L6341-130	31	L6363-110	29	L6395-1E0	21
L5916-YIJ	47	L6105-8E4	12	L6341-1E0	26	L6364-130	29	L6395-110	21
L5916-ZEJ	47	L6106-830	12	L6341-1E0	31	L6364-1E0	29	L6398-1EF	78
L5916-ZIJ	47	L6106-8E0	12	L6341-110	26	L6364-110	29	L6398-1EL	78
L5960-100	65	L6107-830	12	L6341-110	31	L6367-130	32	L6398-11F	78
L5960-300	65	L6107-8E0	12	L6345-130	20	L6367-1E0	32	L6398-11L	78
L5961-100	65	L6108-830	12	L6345-1E0	20	L6367-110	32	L6408-130	129
L5962-100	65	L6108-8E0	12	L6345-110	20	L6368-130	32	L6408-1E0	129
L5962-300	65	L6109-830	12	L6347-130	25	L6368-1E0	32	L6408-110	129
L5963-100	65	L6109-8E0	12	L6347-130	30	L6368-110	32	L6411-130	129
L5963-300	65	L6110-834	12	L6347-1E0	25	L6369-130	32	L6411-1E0	129
L5964-100	65	L6110-8E4	12	L6347-1E0	30	L6369-1E0	32	L6411-110	129
L5964-300	65	L6111-830	13	L6347-110	25	L6369-110	32	L6417-130	129
L6033-130	91	L6111-8E0	13	L6347-110	30	L6370-110	29	L6417-1E0	129
L6033-110	91	L6112-830	13	L6352-130	25	L6371-130	33	L6417-110	129
L6034-130	91	L6112-8E0	13	L6352-130	30	L6371-110	33	L6419-130	129
L6034-110	91	L6113-830	13	L6352-1E0	25	L6372-130	31	L6419-1E0	129
L6052-130	90	L6113-8E0	13	L6352-1E0	30	L6372-1E0	31	L6419-110	129
L6052-1E0	90	L6114-830	13	L6352-110	25	L6372-110	31	L6420-230	119
L6052-110	90	L6114-8E0	13	L6352-110	30	L6373-130	30	L6420-2E0	119
L6053-130	90	L6115-834	13	L6356-130	22	L6373-1E0	30	L6420-210	119
L6053-1E0	90	L6115-8E4	13	L6356-1E0	22	L6373-110	30	L6427-130	129
L6053-110	90	L6316-1E5	59	L6356-110	22	L6374-130	30	L6427-1E0	129
L6054-130	90	L6316-115	59	L6356-B30	22	L6374-1E0	30	L6427-110	129
L6054-1E0	90	L6629-130	35	L6356-BE0	22	L6374-110	30	L6436-130	129
L6054-110	90	L6629-110	35	L6356-B10	22	L6375-130	31	L6436-1E0	129

CLAVE	PÁGINA	CLAVE	PÁGINA	CLAVE	PÁGINA	CLAVE	PÁGINA	CLAVE	PÁGINA
L6436-110	129	L6504-130	144	L6612-130	27	L7003-610	162	L7302-913	182
L6438-130	129	L6504-1E0	144	L6612-1E0	27	L7004-110	163	L7302-919	182
L6438-1E0	129	L6504-110	144	L6613-130	27	L7004-110	163	L7303-910	181
L6438-110	129	L6514-130	141	L6613-1E0	27	L7004-610	163	L7310-613	183
L6440-130	129	L6514-110	141	L6613-110	27	L7004-610	163	L7310-61M	183
L6440-1E0	129	L6515-130	141	L6614-130	27	L7005-110	163	L7310-61M	183
L6440-110	129	L6515-110	141	L6614-1E0	27	L7005-110	163	L7310-613	183
L6442-130	129	L6516-130	141	L6614-110	27	L7005-610	163	L7310-61M	183
L6442-1E0	129	L6516-110	141	L6701-130	14	L7005-610	163	L7310-913	183
L6442-110	129	L6548-1E0	96	L6701-1E0	14	L7006-110	163	L7310-91M	183
L6443-130	129	L6548-110	96	L6702-130	14	L7006-110	163	L7310-913	183
L6443-1E0	129	L6549-1E0	96	L6702-1E0	14	L7006-610	163	L7310-91M	183
L6443-110	129	L6549-110	96	L6703-130	14	L7006-610	163	L7320-613	184
L6471-1E0	94	L6551-130	95	L6703-1E0	14	L7017-110	165	L7320-61M	184
L6471-110	94	L6551-110	95	L6704-130	14	L7017-110	165	L7320-613	184
L6472-1E0	94	L6552-130	95	L6704-1E0	14	L7017-610	165	L7320-61M	184
L6472-110	94	L6552-110	95	L6705-130	14	L7017-610	165	L7320-913	184
L6474-1E0	95	L6553-130	95	L6705-1E0	14	L7018-110	165	L7320-91M	184
L6474-110	95	L6553-110	95	L6706-130	14	L7018-110	165	L7320-913	184
L6475-1E0	95	L6554-130	95	L6706-1E0	14	L7018-610	165	L7320-91M	184
L6475-110	95	L6554-110	95	L6801-530	107	L7018-610	165	L7330-913	185
L6477-1E0	94	L6555-130	95	L6801-510	107	L7019-110	164	L7330-91M	185
L6477-110	94	L6555-110	95	L6812-530	107	L7019-110	164	L7330-913	185
L6478-1E0	94	L6556-130	95	L6812-510	107	L7019-610	164	L7330-91M	185
L6478-110	94	L6556-110	95	L6838-530	110	L7019-610	164	L7340-913	186
L6481-130	144	L6579-130	129	L6838-510	110	L7020-110	164	L7340-91M	186
L6481-1E0	144	L6579-110	129	L6839-530	110	L7020-110	164	L7340-913	186
L6481-110	144	L6601-130	24	L6839-510	110	L7020-610	164	L7340-91M	186
L6482-110	144	L6601-1E0	24	L6840-530	110	L7020-610	164	L7341-913	187
L6483-110	144	L6601-110	24	L6840-510	110	L7111-1E0	168	L7341-91M	187
L6484-130	144	L6602-130	24	L7001-110	162	L7112-1E0	168	L7341-913	187
L6484-1E0	144	L6602-1E0	24	L7001-110	162	L7114-1E0	168	L7341-91M	187
L6484-110	144	L6602-110	24	L7001-610	162	L7117-1E0	168	L7350-610	190
L6494-130	144	L6603-130	24	L7001-610	162	L7121-1E0	169	L7350-6B0	190
L6494-1E0	144	L6603-1E0	24	L7002-110	162	L7124-1E0	169	L7351-610	191
L6494-110	144	L6603-110	24	L7002-110	162	L7126-1E0	169	L7351-6B0	191
L6501-110	144	L6604-130	24	L7002-610	162	L7128-1E0	169	L7352-610	191
L6502-1E0	144	L6604-1E0	24	L7002-610	162	L7265-630	203	L7352-6B0	191
L6502-110	144	L6604-110	24	L7003-110	162	L7301-913	181	L7423-615	201
L6503-1E0	144	L6611-130	27	L7003-110	162	L7301-919	181	L7423-619	201
L6503-110	144	L6611-1E0	27	L7003-610	162	L7302-910	182	L7423-61E	201

CLAVE	PÁGINA	CLAVE	PÁGINA	CLAVE	PÁGINA
L7423-61H	201	L7716-6H0	207	P3785-000	130
L7423-615	201	L7501-6H0	210	P3787-000	89
L7423-619	201	L7592-6H0	210	P3789-000	89
L7423-61E	201			P3790-000	89
L7423-61H	201	P		P3791-000	89
L7424-615	202	P0014-000	123	P3792-000	89
L7424-619	202	P0017-000	123	P3721-000	145
L7424-61E	202	P0018-000	123	R	
L7424-61H	202	P0019-000	123	R1001-000	230
L7424-615	202	P0021-000	123	R1002-000	230
L7424-619	202	P0023-000	123	R1003-000	230
L7424-61E	202	P0058-000	230	R1003-100	230
L7424-61H	202	P0059-000	230	R1004-000	230
L7445-635	198	P0120-000	201	R1004-100	230
L7445-63F	198	P0175-000	230	R1005-000	230
L7445-6E5	198	P0217-000	230	R1005-100	230
L7445-6EF	198	P0320-100	131	R1006-000	230
L7451-630	199	P0322-600	198	R1006-100	230
L7451-6E0	199	P0323-600	198		
L7452-630	199	P0324-600	198		
L7452-6E0	199	P0364-600	198		
L7453-630	200	P0365-600	198		
L7453-6E0	200	P0366-600	198		
L7454-630	200	P3703-000	131		
L7454-6E0	200	P3704-000	130		
L7480-635	198	P3705-000	131		
L7480-63F	198	P3706-000	131		
L7480-6E5	198	P3707-000	131		
L7480-6EF	198	P3710-000	131		
L7491-630	202	P3712-000	130		
L7492-630	202	P3734-100	35		
L7590-6H0	206	P3736-000	131		
L7630-6E0	194	P3737-000	131		
L7630-6H0	194	P3738-000	131		
L7635-640	194	P3758-000	130		
L7635-6E0	194	P3759-000	130		
L7640-640	194	P3760-000	130		
L7640-6E0	194	P3766-000	130		
L7503-6H0	212	P3767-000	130		
L7599-6H0	212	P3768-000	130		
L7712-6H0	207	P3777-000	130		



MAGG

M.R.

QUE BIEN SE VE

CENTRO DE VENTA Y MANUFACTURA
San Luis Tltilco No. 30 Col. Parque Industrial
Naucalpan. C.P. 53489, Naucalpan,
Estado de México.
Tel: (55) 5300 0646
Fax: (55) 53006965
email: magg@electromag.com.mx
www.magg.com.mx

MONTERREY
General Manuel M. González No. 1303
Col. Niño Artillero
C.P. 64280 Monterrey, Nuevo León.
Tel: (81) 8351 8441
Fax: (81) 8351 0392
email: mty@electromag.com.mx

GUADALAJARA
Calle Primavera No. 2470
Col. Fresno Poniente
C.P. 44900 Guadalajara, Jalisco.
Tel: Fax: (33) 3811 4722
email: gdl@electromag.com.mx

QUERÉTARO
Pirineos No. 515 Bodega 14
Micro Parque Industrial Santiago
Col. Parque Industrial Benito Juárez
C.P. 76120 Querétaro, Querétaro.
Tel: (44) 2210 2090
Fax: (44) 2182 2762
email: qro@electromag.com.mx

PUEBLA
30 Norte No. 604 Bodega 20
entre calles 6 y 8 Ote.
Col. Resurgimiento.
C.P. 72370 Puebla, Puebla.
Tel: (22) 2236 8222
Fax: (22) 2235 3553
email: pue@electromag.com.mx

MÉXICO D.F.
Victoria No. 32-101
Col. Centro.
C.P. 06050 México, D.F.
Tel: (55) 5518 4599
Fax: (55) 5512 3771
email: vic@electromag.com.mx

MÉRIDA
Calle 23 no. 391, entre 48 y 50
Col. Ampliación Cuidad Industrial.
Paseos de Itzincab
C.P. 97392 Umán, Yucatán
Tel: (99) 9919 1537
email: med@electromag.com.mx

Tijuana
San José y/o San Martín No. 16621
Col. Río Tijuana 3ra. Etapa
C.P. 22010 Tijuana Baja California
Tel: (66) 49061042 / (66) 49021058
email: tijuana@lectromag.com.mx